

Staff Report

for the Board of Directors' Meeting of June 23, 2021

TO: Board of Directors

FROM: Doug Roderick, P.E., Interim Engineering Manager

DATE: June 9, 2021

SUBJECT: Urban Water Management Plan (FATR# 1034) – Board Workshop
ENGINEERING

RECOMMENDATION:

Receive a presentation from Zanjero consultants regarding the Public Draft Urban Water Management Plan (UWMP) and conduct a workshop.

BACKGROUND:

The California Water Code (CWC) requires every urban water supplier providing water for municipal purposes either directly or indirectly to more than 3,000 customers or supplying more than 3,000 acre-feet of water annually to adopt and submit an Urban Water Management Plan (UWMP) every five years to the California Department of Water Resources (DWR). The specific planning requirements are in the CWC Division 6, Part 2.6 Urban Water Management Planning. The DWR develops guidebooks to assist water suppliers in the development of the UWMP.

The core requirements for the UWMP include:

- An overview description of reliability of supplies, projected supplies, and the strategy for meeting water needs
- A description of the water service area
- A description of the existing and planned supply sources.
- Estimates of past, present, and projected water use
- 20x2020 analysis and target compliance
- A description of water conservation Demand Management Measures (DMMs) already in place and planned, and other conservation measures
- Inclusion of a 5-year Drought Risk Assessment
- A description of the Water Shortage Contingency Plan/Conservation Program

The Board approved a contract with Zanjero to complete the UWMP in accordance with legislative requirements. Public input on these documents is an important part of the UWMP development.

The Public Draft UWMP was released for public review on June 7, 2021. In addition to this workshop, a second workshop will be held on the evening of June 24, 2021. Staff currently plans to have the public hearing on the UWMP at the July 14, 2021 Board meeting.

Staff seeks input from the Board and members of the public regarding the Public Draft UWMP. Following the presentation, a Board workshop will be conducted. Written comments received up to July 2, 2021, will be included in the Board packet for the public hearing. Written comments received after that date and up to and including the public hearing will be incorporated as an appendix to the 2020 UWMP.

Based on input received during the Board workshops and per Board direction, revisions to the document may be necessary. Both the original draft document and revised red-lined version of the document will be included in the Board packet for the public hearing.

BUDGETARY IMPACT:

None

Attachments: (2)

- Public Draft UWMP Redline Version
- Zanjero Presentation



Nevada Irrigation District

2020 Urban Water Management Plan

Public Draft - June 14 Version

June - 2021

Nevada Irrigation District

2020 Urban Water Management Plan

Public Draft - June 14

June - 2021

*insert PE stamp
for final*



ZANJERO

Table of Contents

1	URBAN WATER MANAGEMENT PLAN INTRODUCTION AND OVERVIEW.....	1
1.1	PLAN SUMMARY	1
1.2	BASIS FOR PREPARING PLAN.....	2
1.3	COORDINATION AND OUTREACH	3
1.4	PLAN SUBMITTAL AND AVAILABILITY	3
2	WATER SERVICE AND SYSTEM DESCRIPTION.....	5
2.1	GENERAL DESCRIPTION	5
2.2	SERVICE AREA CLIMATE.....	5
2.3	CURRENT AND PROJECTED LAND USE.....	7
2.3.1	<i>Planned Projects</i>	8
2.4	SOCIAL, ECONOMIC, AND DEMOGRAPHIC FACTORS	10
2.5	CURRENT AND PROJECTED CONNECTIONS	11
2.5.1	<i>Retail Customers</i>	11
2.5.2	<i>City of Lincoln</i>	14
2.5.3	<i>Wholesale Customers</i>	15
2.5.4	<i>Summary of Current and Projected Connections</i>	15
2.6	CURRENT AND PROJECTED CUSTOMER POPULATION	16
3	WATER USE CHARACTERIZATION AND PROJECTED DEMANDS	19
3.1	HISTORICAL DEMANDS.....	19
3.1.1	<i>Treated Water Retail Customers</i>	19
3.1.2	<i>Treated Water Wholesale Customers</i>	20
3.1.3	<i>Raw Water Wholesale Customers</i>	21
3.1.4	<i>Raw Water Retail Customers</i>	22
3.2	WATER LOSS.....	25
3.3	ENVIRONMENTAL INSTREAM FLOW REQUIREMENTS.....	25
3.4	WATER DEMAND PROJECTION SUMMARY.....	26
3.5	RELIABILITY ANALYSIS WATER DEMAND PROJECTION	28
3.6	LOW INCOME DEMAND PROJECTION	29
3.7	SBX7 COMPLIANCE.....	29
4	WATER SUPPLY CHARACTERIZATION	31
4.1	SURFACE WATER SUPPLY.....	31
4.1.1	<i>Water Rights</i>	31
4.1.2	<i>Purchased or Imported Water</i>	33
4.2	GROUNDWATER.....	33
4.3	STORMWATER	33
4.4	WASTEWATER AND RECYCLED WATER	33
4.4.1	<i>Wastewater Collection, Treatment, and Disposal</i>	34
4.4.2	<i>Recycled Water System Description</i>	37
4.4.3	<i>Potential, Current, and Projected Recycled Water Uses</i>	37
4.4.4	<i>Actions to Encourage and Optimize Future Recycled Water Uses</i>	38
4.5	DESALINATED WATER OPPORTUNITIES	38
4.6	WATER EXCHANGE AND TRANSFERS	38
4.7	FUTURE WATER PROJECTS	38
4.8	SUMMARY OF EXISTING AND PLANNED SOURCES OF WATER	39
4.9	SPECIAL CONDITIONS	40
4.9.1	<i>Climate Change Effects</i>	40

4.9.2	<i>Climate Change Impacts</i>	42
4.9.3	<i>Regulatory Conditions and Project Development</i>	43
4.10	ENERGY INTENSITY	44
5	WATER SUPPLY RELIABILITY AND DROUGHT RISK ASSESSMENT	45
5.1	WATER SUPPLY RELIABILITY ASSESSMENT	45
5.1.1	<i>Constraints on Water Sources</i>	45
5.1.2	<i>Reliability by Type of Year</i>	47
5.2	DROUGHT RISK ASSESSMENT.....	51
6	DROUGHT PLAN	52
6.1	LEGAL AUTHORITIES	52
6.2	RESILIENCE PLANNING	53
6.3	WATER SUPPLY RELIABILITY ANALYSIS.....	53
6.4	ANNUAL WATER SUPPLY AND DEMAND ASSESSMENT	54
6.5	WATER SHORTAGE STAGES AND RESPONSES	55
6.5.1	<i>Normal Water Supply</i>	56
6.6	ENFORCEMENT AND VARIANCES.....	64
6.7	COMMUNICATION PROTOCOLS	65
6.8	FINANCIAL CONSEQUENCES OF DROUGHT PLAN	65
6.9	MONITORING, REPORTING, AND REFINEMENT	66
6.10	RESPONSE ACTION ESTIMATES.....	66
6.11	PLAN ADOPTION, SUBMITTAL, AND AVAILABILITY	69
6.12	SEISMIC RISK ASSESSMENT AND MITIGATION	69
7	DEMAND MANAGEMENT MEASURES	70
7.1	WATER WASTE PREVENTION ORDINANCES	70
7.2	METERING.....	70
7.3	CONSERVATION PRICING	71
7.4	PUBLIC EDUCATION AND OUTREACH	71
7.5	PROGRAMS TO ASSESS AND MANAGE DISTRIBUTION SYSTEM REAL LOSS	73
7.6	WATER CONSERVATION PROGRAM COORDINATION AND STAFFING SUPPORT	73
7.7	OTHER DEMAND MANAGEMENT MEASURES.....	74

- Appendix A: DWR Compliance Checklist
- Appendix B: Notification and Public Hearing Outreach
- Appendix C: 2020 UWMP and WSCP Adoption Resolutions
- Appendix D: NID Conservation Information
- Appendix E: References

List of Acronyms and Abbreviations

Act	Urban Water Management Act	GCM	Global Climate Model
AF	Acre-feet	GPCD	Gallons per capita per day
AFY	Acre-feet per year	Guidebook	Urban Water Management Plan Guidebook 2020
AMI	Automatic Metering Infrastructure	HET	High Efficiency Toilets
AMR	Automatic Meter Reading	kWh	Kilowatt Hour
AWWA	American Water Works Association	mgd	Million gallons per day
CABY	Cosumnes, American, Bear, Yuba Integrated Regional Water Management Group	MWELD	Model Water Efficient Landscape Ordinance
CALGreen	California Green Building Standards Code	N/A	Not Applicable
CII	Commercial, Industrial, and Institutional	NCRDC	Nevada County Resource Conservation District
CIMIS	California Irrigation Management Information System	NID	Nevada Irrigation District
CRC	California Railroad Commission	PCWA	Placer County Water Agency
CWC	California Water Code	PG&E	Pacific Gas and Electric
DEW	Drier, extreme warming scenario	SMD	Sewer Maintenance District
District	Nevada Irrigation District	SSWD	South Sutter Water District
DMM	Demand Management Measure	SVI	Sacramento Valley Index
DOF	California Department of Finance	SWRCB	California State Water Resource Control Board
DRA	Drought Risk Assessment	USGS	United States Geological Survey
DWR	California Department of Water Resources	UWMP	Urban Water Management Plan
FERC	Federal Energy Regulatory Commission	WMW	Wetter, moderate warming scenario
ft	Feet/Foot	WRCC	Western Regional Climate Center
		WTP	Water Treatment Plant
		WWTP	Wastewater Treatment Plant

1 Urban Water Management Plan Introduction and Overview

This Urban Water Management Plan (UWMP) was prepared for the Nevada Irrigation District (NID or District) in cooperation with the District staff. The District was organized in 1921 under the California Irrigation District Act of 1897 as a nonprofit water agency and operates under Division 11 of the State Water Code.

The Urban Water Management Act (Act) became part of the California Water Code (CWC) with the passage of Assembly Bill 797 during the 1983-1984 regular session of the California Legislature. The CWC requires every urban water supplier providing water for municipal purposes either directly or indirectly to more than 3,000 customers or supplying more than 3,000 acre-feet of water annually (AFY) to adopt and submit an Urban Water Management Plan every five years to the California Department of Water Resources (DWR). The specific planning requirements are in the CWC Division 6, Part 2.6 Urban Water Management Planning.

Subsequent legislation has been passed that updates and provides for additional requirements for the UWMPs and water management. In particular, SBX7- 7 Water Conservation, required the State to achieve a 20 percent reduction in urban per capita water use by December 31, 2020, known as 20x2020. Reporting of 20x2020 compliance is incorporated into the 2020 UWMP requirements. Other inclusions in the UWMP originating from legislative requirements include reporting on energy intensity, an expanded Water Shortage Contingency Plan, and a 5-Year Drought Risk Assessment.

The core requirements for the UWMP include:

- An overview description of reliability of supplies, projected supplies, and the strategy for meeting water needs.
- A description of the water service area.
- A description of the existing and planned supply sources.
- Estimates of past, present, and projected water use.
- 20x2020 analysis and target compliance.
- A description of water conservation Demand Management Measures (DMMs) already in place and planned, and other conservation measures.
- Inclusion of a 5-Year Drought Risk Assessment.
- A description of the Water Shortage Contingency Plan/Conservation Program.

The 2020 UWMP must submit data in specific tables to DWR. DWR has provided these tables and this UWMP utilizes the provided tables with minor changes to format or organization where applicable. NID's 2020 UWMP presents each required element per DWR's Urban Water Management Plan Guidebook 2020 (Guidebook). A copy of the DWR checklist for compliance is included in Appendix A.

1.1 Plan Summary

The District supplies treated and raw water to municipal and raw water customers. The majority of water use is by the raw water customers. Raw water customers include commercial agriculture, small-scale agriculture, and other irrigation uses that contribute to the community's rural character.

The water supply system relies on diverting snow-melt runoff and capturing runoff flows in District reservoirs for use during the irrigation summer when runoff is reduced. The District's water rights including diversion and storage total approximately 450,000 acre-feet, though the amount that is actually available for use is less due to temporal differences between water rights, runoff season, and irrigation season needs.

This plan utilizes recent customer connection statistics and California Department of Finance population projections to develop customer and demand projections. A pending new Federal Energy Regulatory Commission (FERC) license will also add significant environmental instream flow requirements that depending on the year type, could increase unrecoverable flow requirements from the existing 7,665 acre-feet up to 59,527 acre-feet. Total 2020 demands were 161,678 acre-feet. Overall water demands are projected to increase up to ~~5035~~ percent through 2040 to a range of approximately ~~199175,000-242 AF-~~ 218,000 acre-feet per year. Without the new FERC requirements, projected demands only increase ~~18three~~ percent, up to approximately ~~199166,000~~ acre-feet.

The District's water supplies are sufficient to meet customer and other demands during normal hydrologic years. However, the District projects supply to demand shortages during single and 5-year drought periods due to projected reduced watershed runoff. To address these shortages, the District's Drought Plan identifies six drought stages that include actions for the District and customers to implement to either reduce demand and/or increase supplies. Drought year impacts can be significantly mitigated through purchase of supply from PGE. However, the PGE supply is a highly variable, making it unreliable during dry years. In addition, the District's supply strategy relies heavily on carry over storage in its reservoirs. Depending on management of the storage over year to year, supply shortages may vary from values reported in this Plan.

As a mostly rural area primarily dependent on its snowmelt-based supply, the District faces unique challenges in projecting its future supplies and demands. The character of the area and water management practices of the past may be different in the future. As such, the District is in the early stages of a long-term visioning and planning effort to better understand potential future conditions and needs, and identify management and operational practices to meet those needs. The process, Plan For Water, will identify optional water management practices when triggering points in supply, demand, regulatory, legal, and other events are reached. These practices may include supply projects, demand management efforts, operational changes, policy changes, and others.

1.2 Basis for Preparing Plan

The District supplies treated water within portions of the District's service area. Based on the number of connections and total volume delivered, NID is considered an urban retail water supplier and is required to update the UWMP. Based on the small volume of wholesale water supplied to other water providers, the District is not considered an "urban wholesale water supplier" as defined by CWC §10608.12(t). Table 1-1 presents the public water system name and number for each of the District's public water systems.

Table 1-1. Public Water System Information

Public Water System Number	Public Water System Name	Number of Municipal Connections	Volume of Water Supplied 2020 (AF)
CA2910004	Nevada ID - E. George, Banner Mountain	6,288	2,757
CA2910006	Nevada ID - Loma Rica	5,015	1,939
CA2910014	Nevada ID - Lake of Pines	2,555	1,113
CA2910023	Nevada ID - Lake Wildwood	3,248	1,058
CA311026	Nevada ID - North Auburn	2,499	1,780
CA5810005	Nevada ID - Smartsville	43	10
Total:		17,093	19,648

1.3 Coordination and Outreach

The District coordinated this UWMP with other agencies and the community. Notice to the cities of Grass Valley, Lincoln, and Nevada City, as well as Nevada, Placer, and Yuba counties were provided on December 11, 2020, regarding the District’s intentions of updating the UWMP, fulfilling the requirement to provide notice at least 60 days prior to the public hearing. A summary of the outreach efforts is provided in Table 2-2.

The District conducted *insert number* public workshops at Board of Directors meetings to review and discuss the Plan. A public hearing for the plan was held on *insert date*. Public notification regarding these workshops and the hearing were advertised on the District’s website and news releases. For the public hearing, the District notified the cities of Grass Valley, Lincoln, and Nevada City, as well as Nevada, Placer, and Yuba counties, as well as official notification in a news publication. Outreach and notification materials are presented in Appendix B.

Add results from public workshop...

The public hearing and adoption were conducted on [DATE]. The NID Board of Directors Resolution XXX adopting this 2020 UWMP is included in Appendix C.

1.4 Plan Submittal and Availability

Pursuant to DWR requirements, this 2020 UWMP was submitted to the California State Library, cities of Grass Valley, Lincoln, and Nevada City, and the counties of Nevada, Placer, and Yuba on [DATE].

This 2020 UWMP and applicable submittal tables were electronically submitted to DWR on [DATE].

This 2020 UWMP is available to the public electronically on the District’s website. Due to COVID 19, a hard copy at the District is not available for review.

Table 1-2. Summary of Coordination, Adoption, and Submittal Activities (not final until Board approved and submitted to State)

Potentially interested parties	Notified of UWMP preparation	Requested copy of draft	Commented on the draft/action taken by supplier	Notified of public hearing	Attended public hearing	Copy of UWMP sent (date sent)
Nevada County	X					
Placer County	X					
Yuba County	X					
City of Grass Valley	X					
City of Nevada City	X					
City of Lincoln	X					
Yuba Water Agency	X					
Placer County Water Agency	X					
Placer County Agricultural Commissioner	X					
Placer County Farm Bureau	X					
Nevada County Agricultural Commissioner	X					
Nevada County Farm Bureau	X					
General public	X					
District Website	12/11/2020	--	--	--	--	--

2 Water Service and System Description

This section contains a description of the service area and climate, historical and projected connections and population, as well as land uses within the service area.

2.1 General Description

Located on the western slope of the Sierra Nevada Mountain range, the District encompasses 287,000 acres and covers portions of three counties: Nevada, Placer, and Yuba as shown on Figure 2-1, below. The District's watershed is located on the upper reaches of the Yuba River, Bear River, and Deer Creek. The highest peak in the District is at 8,373-foot elevation at English Mountain. The District transports water from high elevation, mountain reservoirs to the lower elevation foothills and into portions of the northern Sacramento Valley near the City of Lincoln.

NID was established as an irrigation district in 1921 and is governed by a five-member Board, which is elected by District voters. Each Board member, representing a division with the District, serves a four-year term.

The District supplies treated water for municipal, domestic, and industrial purposes. Water management infrastructure includes storage, treatment, and conveyance facilities. Many areas and residents within the service area are not served NID water, receiving their water through private groundwater wells or other sources. NID does provide wholesale supply to Nevada City, Grass Valley, and Placer County Water Agency which maintain their own water treatment and distribution systems. The District also serves approximately 5,200 raw water customers with a total reported irrigated acreage of 32,323 acres in 2020.

The District's retail potable water system consists of six service areas. The retail water system connections are predominantly single-family, but also consist of multi-family, commercial, industrial, and institutional customers.

The District owns and operates hydroelectric generation and recreational facilities. The hydroelectric facilities have a capacity of 82.2 megawatts and produced an annual average of 319 MWh between 2016 and 2020. NID began producing power in 1966 with the completion of the Yuba-Bear Power Project, which includes Chicago Park, Dutch Flat, Bowman, and Rollins powerhouses. Recreational facilities owned by the District provide camping, fishing, and boating at Rollins Lake, Scotts Flat Reservoir, and Jackson Meadows – Bowman Lake areas.

2.2 Service Area Climate

Summers are generally dry with mild to hot temperatures. Winters are relatively wet, especially in the upper elevations around Nevada City and Grass Valley, with snow levels usually around 3,500 ft and occasionally as low as 1,000 ft. Based on the historical data obtained from the California Irrigation Management Information System (CIMIS) and the Western Regional Climate Center (WRCC), the District's service area average minimum and monthly maximum temperatures are 26.4 and 92.5 degrees Fahrenheit, respectively.

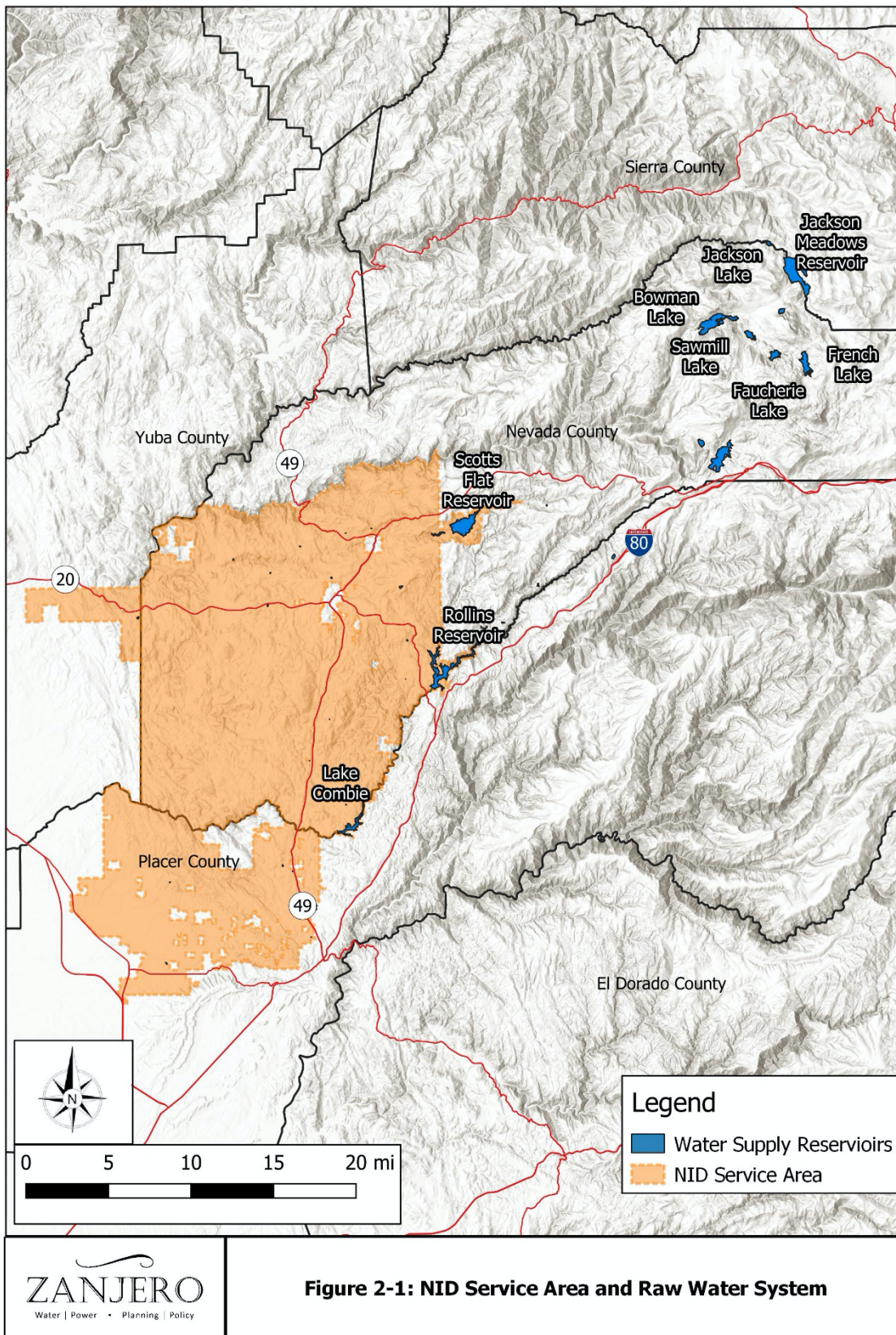

2.3 Current and Projected Land Use

The NID service area includes mainly areas of Nevada County and Placer County, with a small portion in Yuba County. The service area is a unique blend of treated and raw water customers that includes urban, suburban, rural, and agricultural settings.

The Placer County General Plan indicates land uses for the portion of the service area within Placer County primarily consists of Agriculture/Timberland, except for the North Auburn Highway 49 corridor which mainly includes various densities of Residential¹ with scattered Rural Estate, Mixed-Use, and Professional Office. According to Placer County Goal 1.H (and supporting policies), Placer County “shall seek to ensure that new development and public works projects do not encourage expansion of urban uses into designated agricultural areas” (Placer County, 2013). NID assumes no major changes to current land use plans in Placer County for the near-term future.

A portion of the District’s service area lies within the City of Lincoln’s sphere of influence. As the City grows, land use is being modified and developments are actively moving through the planning process. Land use planning for this area is addressed through the City’s General Plan and specific planning process. The City provided projected development and water demands to NID. Projected land-use and connections from the City are presented in Table 2-1. Water service options for the District’s service area within the City of Lincoln continue to be investigated. At this time, NID will utilize the total water demand provided by the City to project supply needs. Pending ongoing investigations, this assumption should be revisited if alternative water service options are selected.

Table 2-1. City of Lincoln Land Use and Connection Projections Within NID Service Area

General Plan Land Use Category	2025 Additional Connections		2030 Additional Connections		2050 Additional Connections		Total Additional Connections	
	Dwelling Units	Acreage	Dwelling Units	Acreage	Dwelling Units	Acreage	Dwelling Units	Acreage
Country Estates	0	--	75	--	500	--	575	--
Low Density Residential	1,000	--	600	--	3,000	--	4,600	--
Medium Density Residential	200	--	0	--	500	--	700	--
High Density Residential	0	--	250	--	500	--	750	--
Total Residential	1,200	--	925	--	4,500	--	6,625	--
Neighborhood Commercial	--	5	--	10	--	0	--	15
Total Non-Residential	--	5	--	10	--	0	--	15

Note: Data provided by the City of Lincoln. Demand projections through the UWMP planning period as provided by Lincoln are presented in Chapter 3.

¹Residential land use sub-groups include a mixture of Low Density (0.4-0.9 acre minimum), Low-Medium Density (2-5 dwelling units/acre), Medium Density (5-10 dwelling units/acre), Rural Low Density (0.9-2.3 acre minimum), and Rural (1-10 acre minimum).

Nevada County is primarily composed of residential, commercial, industrial, agricultural, and public land uses (Nevada County, 2020). Nevada County's Land Use Element of the General Plan reports 56 percent of the county is classified as "Forest" while 30 percent is classified as "Rural". These two land use designations are the two largest categories by acreage. Goal 1.3 of the Land Use Element states, "Within Rural Regions, maintain and enhance the County's pastoral character, existing land use pattern, rural lifestyle, and economy in their natural setting". This goal, and supporting policies, aim to provide related benefits for the conservation of a rural character and preservation of natural resources (Nevada County, 2020). As presented in Nevada County's Land Use Element, the predominant land use within the service area is Rural. Uses for this designation include rural residential, agricultural operations and supporting agricultural production, natural resource production and management, and low-intensity recreation.

NID deliveries to customers in Yuba County are made pursuant to the California Railroad Commission (CRC) Order 15926. NID purchased the Excelsior Water And Power Company's Yuba County holdings in the 1920s and is required to deliver water to the area's customers. Treated water customers are supplied by the Smartsville WTP, while raw water customers are delivered water through the Meade, Town, Ousley Bar, and Farm canals. The Yuba County General Plan identifies this area served by NID as a "Rural Area". Goal CD9 (and supporting policies) aims to maintain the rural nature by preserving the existing character through strategic developmental designs and standards (Yuba County, 2011).

2.3.1 Planned Projects

Planned projects within the District's service area impact the projected number of customer connections and overall treated water demands. In addition to the City of Lincoln planned land use developments listed above. Table 2-2 lists the other planned projects the District is aware of that would connect to the treated water system when built. These projects include treated water service for domestic and commercial purposes as well as private fire services. Each project is at various levels of the planning and implementation process. The number of units, lots, and connections identified in Table 2-2 are subject to change as these are preliminary and based on current information. The District maintains a development and new connection procedure to evaluate each proposed project, approve, and coordinate the implementation with the respective project owner.

The project types listed in Table 2-2 include waterline extensions, potential waterline extensions, master meter, approved projects (not submitted), private fire services, and potential private fire services. Waterline extension projects are defined as projects requiring an extension of an existing waterline, while potential waterline extensions are waterline extension projects that are in a pre-planning phase (District has been made aware, although no City/County permitting has been achieved). Master meter projects are projects that will be provided a master meter, with individual meters yet to be installed. Approved Projects by City/County have been approved, although no application for water service has been submitted to the District. Private fire service projects will be provided water through dedicated meters for fire service, while potential fire service projects are in the pre-planning phase.

Table 2-2. Planned Projects within NID service area

Project Name/Location	No. of Units, Lots, or Connections ¹
Waterline Extension	
Blair Ct	5
Gracie Commons	49
Ridge Village	12
NJUHSD	1
Queen Lil Place	4 to 8
PCGC, Mercy (including PFS)	5
Loma Rica Ranch	240
Towntalk	11
Loma Rica DFWLE	20
American Hill Road	9
Timberwood Estates	45
Potential Waterline Extensions	
Red Dog Road	16
Rincon del Rio	346
The Grove	59
Maranatha DFWLE	21
Timberline at Auburn	858
PCGC	unknown
Table Meadow Road	21
Ali Lane DFWLE	8
Harris Road DFWLE	unknown
Idaho Maryland Mine	30
Master Meter	
Cashin's Field Affordable Housing	59
Brunswick Commons Apartments	41
Grass Valley RV Resort	150
Approved Projects by City/County (not submitted)	
Berriman Ranch	unknown
Atwood 80	65
Hidden Creek Subdivision	23
Kemper Woods Subdivision	17
Joeger 20 Subdivision	17
Kenny Ranch	100
Pendagio Vineyard Estates	95

Project Name/Location	No. of Units, Lots, or Connections ¹
Sunset Grove Homesites	5
Trees Resort at Darkhorse	34
Dorsey Marketplace	unknown
West Olympia Hotel	74 rooms
Private Fire Services	
ZAP Manufacturing	1
Timerline	1
Comfort Plumbing	1
Crown Point Ct	1
Brunswick Commons Apartments	1
Potential Private Fire Services	
Grass Valley RV Resort	1
Cashin's Field Affordable Housing	1

¹Preliminary numbers, subject to change.

2.4 Social, Economic, and Demographic Factors

Social and demographic factors that affect water management planning include the uncertainty in estimating future customer connections and water use per customer.

Future customer connections for both treated water and raw water customers are impacted by both new construction and existing houses/parcels that currently are not customers. Potential future demand for NID water of existing water-using parcels is characterized as “latent demand”. Latent demand affects the customer connection to population growth demand, uncoupling the usual direct relationship between the two. For example, from 2014 through 2020, approximately 60 percent of the new treated water customer connections were classified infill connections, adding new demand from existing housing stock. Latent demand analysis is an important element of NID’s long-term water resources planning efforts and will be further addressed in NID’s Plan for Water. For the purposes of this UWMP, projected connections are based on recent historic new customer rates, as further discussed below.

Treated water use per customer can be affected by many aspects, including plumbing codes, landscaping trends, and indirectly by the recent State-required water budgets. State Water Code now requires a water agency to remain below an overall water budget applied to their service area that consists of maximum allowable water uses for indoor and outdoor residential, landscape, non-residential uses, and water loss. For treated water customers, the indoor budget is set at 55 gallons per capita (gpcd), reducing to 50 gpcd in 2030. The residential outdoor budget is currently under development by DWR and will consist of estimated irrigated landscape areas and evapotranspiration-based water allowances. These regulatory requirements may impact future water use trends, affecting the overall future demands. Unit water use factors are further addressed in Chapter 3.

Raw water customers represent the largest customer by water volume for NID. Raw water customers include commercial agricultural, small agricultural, personal/hobby farms and gardens, golf courses, and other water uses that contribute to the rural character of the service area. Changes to the demographics of the raw water customer may also affect raw water use, depending on new or next-generation owners and their intended water use. Raw water customer unit water demands are further discussed in Chapter 3. Raw water use analysis and future unit demands are also an important element of NID’s long-range water resources planning efforts and will be further addressed in NID’s Plan for Water.

2.5 Current and Projected Connections

The current and projected number of connections is the basis for projected District water demands (treated and raw) for the planning horizon. Annual growth rates for the period 2014 through 2020 are developed and applied to the number of 2020 connections for each customer type to characterize the expected growth within NID’s service area. NID’s customer base includes retail and wholesale customers receiving treated and/or raw water. Additional information on each customer type is presented below.

2.5.1 Retail Customers

Retail services provided by the District make up the majority of customer connections as well as total use. The retail services provided by NID include treated water for consumption and raw water deliveries for various purposes (commercial agricultural, small agricultural, etc.). Retail treated customers consist of the following classifications:

- Single-Family
- Multi-Family
- Commercial
- Industrial
- Institutional and Governmental
- Landscape Irrigation
- Other

The District’s retail treated water customer base increased from 18,900 in 2014 to 19,648 in 2020. During the same period, NID’s retail raw water customers increased from 5,035 to 5,188. Table 2-3 presents the total number of treated and raw water connections, and corresponding growth rate, for the period 2014 through 2020.

Table 2-3. NID Retail Connections for Period 2014 through 2020

Retail Customers	2014	2015	2016	2017	2018	2019	2020	Average Annual Growth
Treated	18,900	19,044	19,132	19,287	19,437	19,524	19,648	0.6%
Raw	5,035	5,044	5,119	5,187	5,162	5,157	5,188	0.5%
District Total:	23,935	24,088	24,251	24,474	24,599	24,681	24,836	0.6%

New retail treated connections can be attributed to “in-fill” or “mainline extension” projects. “In-fill” projects include standby connections (see below), variances, and temporary service lines.

“Mainline extension” projects require infrastructure improvements and are associated with planned District projects and developer projects. For the period 2016 through 2020, 60 percent of the new meter installations are classified as “in-fill” projects, with the remaining 40 percent classified as “mainline extension” projects.

Single Family Customers

NID’s treated customer base primarily consists of Single Family connections, which include various land-use zoning classifications with Placer, Nevada, and Yuba counties. Single Family customers make up 72 percent of NID’s retail customer connections in 2020 while accounting for 60 percent of treated water demands. Proportionally, this customer class represents the largest with respect to treated water connections and use. Figure 2-2 illustrates the number of Single Family connections for the period 2014 through 2020. As seen on the figure, the connections increased from 17,366 (2014) to 17,824 (2020), representing an average annual growth rate of 0.4 percent. This growth rate is applied to the 2020 connections to project the number of Single Family connections out to 2040 (see Table 2-4).

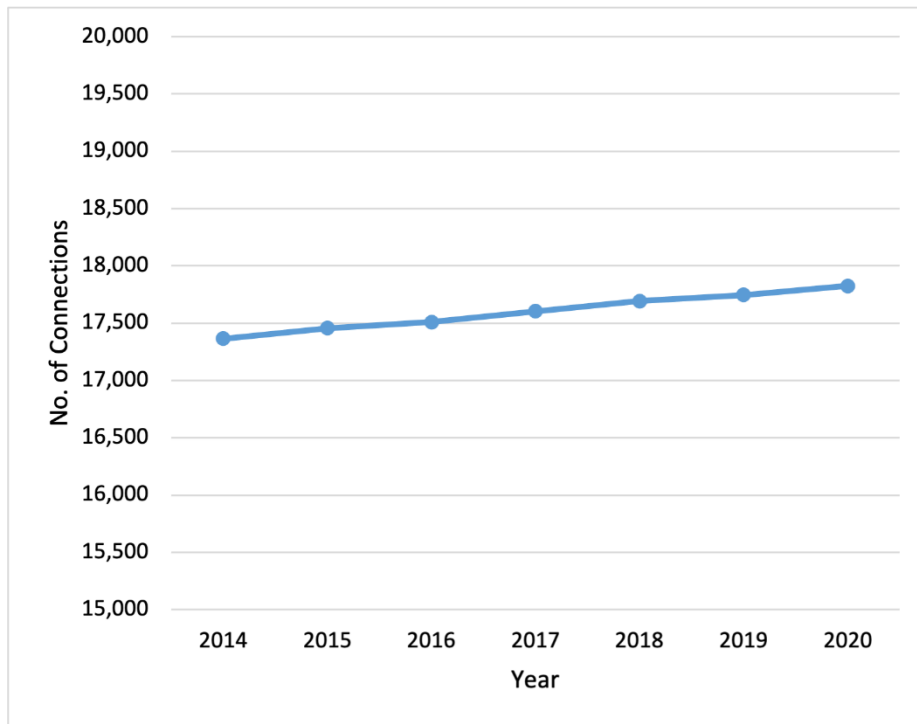

Figure 2-2. Number of Single Family Connections (2014-2020)

Multi-Family Customers: Multi-family connections make up approximately one percent of the District’s 2020 total treated and raw water retail connections. The majority of the multi-family connections are located in North Auburn, specifically Auburn Greens, and have remained a constant 219 connections for the period 2014 through 2020. Based on the land-use projections and rural character of the service area, limited growth is anticipated with respect to the number of multi-family connections. However, planned residential projects, including Mercy First Housing, Loma Rica Ranch, and Rincon del Rio will increase the number of multi-family connections over the

planning horizon. The projected number of multi-family connections assumes an average annual growth of 0.7 percent, resulting in a total of 250 Multi-Family connections by 2040. Depending on the potential approval of future developments, this projection may change.

Commercial Customers: A total of 735 commercial customers were served in 2020, making up three percent of NID's retail customer connections. Commercial customers grew 0.61 percent annually from 2014 through 2020. This growth rate is applied to the 2020 connections to estimate the number of connections for the planning horizon. As shown on Table 2-4, this class is expected to grow to approximately 825 connections by 2040.

Industrial Customers: The District has maintained one industrial customer for the period 2014 through 2020. The District acknowledges the potential for a limited amount of industrial connections in the future and will identify as such when project plans are developed. No new industrial customers are assumed for the planning horizon.

Institutional and Governmental Customers: Institutional and governmental customer connections total 102 for 2020. This represents less than one percent of the District's retail customers. The average annual growth for the period 2014 through 2020 was 0.8 percent. This growth rate is applied to the number of 2020 connections to estimate the projected number of institutional and governmental connections for the planning horizon.

Landscape Customers: In 2020 there were 123 customers on dedicated landscape meters. The growth of these customer connections was two percent annually for the period 2014 through 2020. The recent growth rate reflects State requirements that mandate Commercial, Industrial, and Institutional (CII) accounts using water for irrigation purposes to transition to dedicated landscape meters. The two percent annual growth rate is applied to the 2020 connections to estimate the projected number of landscape customers for the planning horizon. The projected total number of connections for the planning period is presented in Table 2-4.

Other Customers: The other customer classification includes connections used for standby fire services. Per regulatory requirements, these connections are required for new and remodeled developments. There were a total of 644 other connections in 2020. The average annual growth rate for the period 2014 through 2020 is 6.3 percent, reflecting the implementation of the regulatory requirement regarding standby fire service connections. This same growth rate is assumed throughout the planning period.

Raw Water Customers: Retail raw water customers make up the majority of total water use while representing the second-largest retail customer class (by number of connections). NID provides retail service to its raw water customers during the irrigation season (April 15 through October 14), Fall/Winter, and annually. For Fall/Winter and annual service, the District requires irrigation season service. As a result of this policy, the number of Fall/Winter and annual customers are a subset of, and included in, the total number of irrigation season customers.

In 2020, a total of 5,188 customers ordered raw water service from the District, with 744 of those customers ordering deliveries during the Fall/Winter and 296 annually. In 2020 there were an additional 1,148 inactive raw water customer connections (those that did not order water). Figure 2-3 illustrates the total number of Raw Water customers (not including inactive) for the period 2014 through 2020. As seen on the figure, this customer base increased from 5,035 (2014) to 5,188

(2020), representing an average annual growth rate of 0.5 percent. This growth rate is applied to the total number of raw water customers for 2020 to estimate the total number of raw water customers for the planning horizon. Fall/Winter customers grew approximately 4.8 percent annually during the period 2014 through 2020. The number of annual customers, those that use raw water indoors, decreased 2.1 percent annually for the period 2017 through 2020. It is assumed that as these customers connect to the District’s treated water system or drill a well, the number will continue to decrease, as District policy does not allow new annual raw water customers. These growth rates are applied to the number of 2020 connections for each raw water customer subset to estimate the District’s Fall/Winter and annual raw water customers for the planning horizon. 2020 total connections, average annual growth rate applied, and projected number of connections for the District’s raw water customers are presented in Table 2-4.

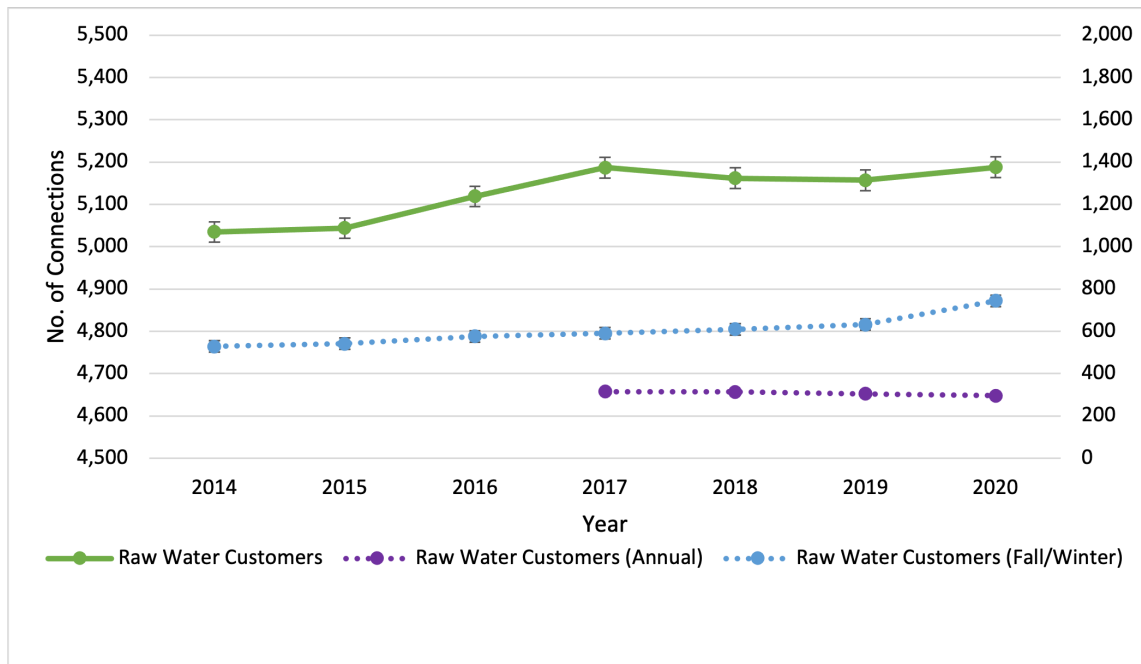

Figure 2-3. Number of Raw Water Customers (2014-2020)

Standby Customers: Standby customers represent parcels fronting treated water distribution lines but are not yet receiving service. At the end of 2020, there were a total of 1,639 standby connections. The total number of standby customers fluctuates throughout the year. Projections for these customers are assumed to be captured by the projections of other customer connections, as a standby customer is converted to a treated water customer. Therefore there are no projections for standby customer counts.

2.5.2 City of Lincoln

The City of Lincoln maintains its own retail water distribution system. In the past, the District has investigated constructing its own water treatment plant to serve its service area in the City of Lincoln. Currently, the District supplies raw water to Placer County Water Agency for treatment, who in turn provides the treated water to the City of Lincoln for retail. For the purposes of this

plan, it is assumed this operation will continue in the near future, and therefore is represented by one raw water wholesale connection to PCWA for the benefit of the City of Lincoln.

2.5.3 Wholesale Customers

Wholesale services include treated and raw water deliveries. Raw water wholesale connections include City of the Grass Valley WTP, Nevada City WTP, and Nevada City School of Arts. Treated water wholesale connections include City of Grass Valley and Lake Vera Mutual Water Company. For this analysis, the total number of wholesale customers is not expected to increase during the planning horizon.

2.5.4 Summary of Current and Projected Connections

As seen from Table 2-3 (above), the treated connections have increased from 18,900 in 2014 to 19,648 in 2020. This represents an increase of approximately four percent over the 2014 number of treated connections. The raw water customers have increased from 5,035 in 2014 to 5,188 in 2020, representing an increase of three percent over the 2014 number of raw water connections.

Table 2-4 presents the number of 2020 active connections by customer class, average annual growth rate applied, and the resulting number of projected connections for the period 2020 through 2040, in five-year increments. Average annual growth rates are developed based on the historical growth rate for each customer classification as described above.

Table 2-4. Current and Projected Connections

Service Area	2020 ¹	Annual Growth Rate	2025	2030	2035	2040
NID Treated Retail Customers						
Single Family	17,824	0.4%	18,206	18,587	18,969	19,351
Multi Family	219	0.7%	227	235	242	250
Commercial	735	0.6%	758	780	803	825
Industrial	1	0.0%	1	1	1	1
Institutional/ Governmental	102	0.8%	106	110	115	119
Landscape	123	2.0%	136	148	161	173
Other	644	6.3%	847	1,049	1,252	1,454
Standby	1,639	included in other customer categories				
Retail Treated Water Total:	21,287		20,279	20,910	21,541	22,172
NID Treated Wholesale						
Lake Vera Mutual Water Company	1	n/a	1	1	1	1
Grass Valley	1	n/a	1	1	1	1
Lincoln NID Service Area – Raw Water Supplied to PCWA						
PCWA connection	1	n/a	1	1	1	1
NID Raw Water Customers						
Irrigation Season	5,188	0.5%	5,316	5,4435,344	5,5715,367	5,6985,392
Fall/Winter Season (subset of total)	744	4.8%	924	1,104960	1,284996	1,4641,032
Annual Use (subset of total)	296	-2.1%	264	233258	201252	169245
NID Raw Water Wholesale						
Nevada City	1	n/a	1	1	1	1
Grass Valley	1	n/a	1	1	1	1
Nevada City School of Arts	1	n/a	1	1	1	1

¹Number of active accounts.

2.6 Current and Projected Customer Population

The NID retail service area covers multiple counties, cities, and other places identified in the census and California Department of Finance population analysis. Therefore, the population is represented by portions of multiple census places, tracts, and blocks. The California Department of Water Resources provides a tool for water agencies with similar service area issues to estimate customer population. The DWR population tool utilizes the census block data and treated water service area to parse the population count into the actual treated water service area. Using the number of single

family and multi family connections, the tool provides a population per connection that is used to estimate the treated water customer population. As some of the population within NID’s service area is served by private wells or other suppliers, the DWR population tool does not provide the actual customer population but does provide the population per connection used to estimate the population.

In the 2015 UWMP, NID replicated the DWR methodology to develop the population per connection and subsequent population estimation. Results from the 2015 effort indicate the District’s person-per-connection ratio of 2.84. For planning purposes, this ratio from the District’s 2015 UWMP is utilized to estimate NID’s 2020 customer population and projections. Current and projected treated water customer population is presented in Table 2-5. Multi-family connections are assumed to have an average of four dwelling units per connection. It is recommended NID revisit this metric after the release of the 2020 Census data, and update projections as applicable.

Table 2-5. Current and Projected Treated Water Customer Population

Population Served	2020	2025	2030	2035	2040
	52,733	53,839	54,927	56,016	57,104

Census year population estimates for the total service area and the District’s treated customer base are presented in Table 2-6. The DWR population tool methodology reports the District’s total service area population based on District boundary and census year block data as reported in the 2015 UWMP.

Table 2-6. Census Year Population Comparison

Year	Total Service Area Population	Treated Water Customer Population	% of Service Area Population
2000	82,941	39,374	47.5%
2010	93,690	49,023	52.3%
Ave Annual Growth Rate	1.2%	2.2%	--

The District’s total service area population increased at a rate of 1.2 percent annually between the census years, while the treated water customer base increased annually by 2.2 percent. The different growth rates between the service area population and treated customers could be attributed to existing residents connecting to the NID treated water system, or new development prioritizing treated water connections versus private wells.

Population projections developed by the California Department of Finance (DOF) for Placer and Nevada counties are presented in Table 2-7. The projections incorporate historic populations and demographic trends, and are obtained from DOF’s Table P-2A (Total Population for California and Counties, accessed 2021). According to DOF methodology, the previous year populations are used as a starting point, with factors such as births, deaths, and migration patterns applied to estimate the target year population. The total population for both counties is expected to increase by approximately 0.79 percent annually for the period 2020 through 2040.

Table 2-7. California Department of Finance Population Projections for Nevada and Placer Counties

County	2020	2025	2030	2035	2040
Nevada County	97,439	99,131	101,004	102,479	103,193
Average Annual Growth Rate from 2020	--	0.34%	0.36%	0.34%	0.29%
Placer County	397,469	414,544	437,655	458,999	476,434
Average Annual Growth Rate from 2020	--	0.84%	0.97%	0.96%	0.91%
Total	494,908	513,675	538,659	561,478	579,627
Average Annual Growth Rate from 2020	--	0.75%	0.85%	0.84%	0.79%

Source: California Department of Finance, Table P-2A (Total Population for California and Counties, accessed 2021).

In addition to the unincorporated areas of each county, the DOF county-wide projections include populations for the communities of Rocklin, Roseville, Lincoln, and Loomis (Placer County), as well as Grass Valley, Nevada City, and Truckee (Nevada County). Some of these communities are expecting higher growth, and therefore, the total population reported in Table 2-7 is likely not reflective of the expected level of growth and associated population estimates for the District’s service area within Placer and Nevada counties. However, the county-wide population projections do provide a general level of understanding of county-wide growth, which is expected to affect the NID customer projections. It is recommended the District further analyze customers and population growth when the 2020 census data is available as part of the Plan For Water process.

3 Water Use Characterization and Projected Demands

This section presents the past treated and raw water system demands, demand characterization, and projected demands.

3.1 Historical Demands

The District's historical demands for the period 2014 through 2020 are described per service type. The customer types include treated retail, treated wholesale, raw retail, raw wholesale, and instream environmental. In summary, retail raw water demands make up the majority of total demands, averaging 94 percent for the period. 2020 total wholesale and retail treated water demands were the highest for the period and showed an increase of eight percent over 2019 demands. The increase in treated water use may be reflective of the recent pandemic resulting in customers staying at home.

3.1.1 Treated Water Retail Customers

The District serves treated water to retail customers. All of NID's treated retail customers are metered. Customer categories consist of single family and multi-family residential connections, as well as commercial, industrial, institutional and governmental, landscape, and "other" customer types. Demand information for each customer category is presented below, including unit factor demands (annual demand per connection type) developed for projecting future water demands. Historic treated water retail customer demands are summarized in Table 3-1.

Single Family: Single family customers averaged approximately five percent of total retail demands (including raw water demands) for the period 2014 through 2020, while averaging 74 percent of the total retail treated use for the same period. The single family customers are NID's largest retail treated customer base. The 2020 unit demand factor of 0.36 acre-feet per year per connection (AFY/connection) and is used for projecting demands. As discussed in Chapter 2, the state will soon mandate indoor and outdoor water budgets for residential. The indoor budget starts at 55 gallons per capita day (gpcd) in 2023, and reduces to 50 gpcd in 2030. Using the capita per connection from Chapter 2 of 2.84, 50 gpcd translates to 0.16 AFY. Therefore, approximately one ~~third~~half of the assumed unit demand factor of 0.36 AFY/connection is indoor demand. The District will revisit unit demand factors once the state has finalized the outdoor water use budgets.

Multi-Family: The multi-family customers primarily consist of residents in North Auburn, where the District provides water to 175 fourplexes. This customer base averaged eight percent of total treated retail demands for the period 2014 through 2020. The use per connection averaged 2.82 AFY/connection for the same period. This unit demand factor is utilized in projecting demands through 2040.

Commercial: Commercial demands averaged ten percent of treated retail demands for the period 2014 through 2020, representing the second largest customer base (by total use) for the District's treated retail customers. Total use per connection for the same period averaged 1.06 AFY/connection. This unit demand factor is utilized in projecting demands through 2040.

Industrial: Industrial water use is minimal within the District's retail service area. No use was reported from 2014 through 2019, with 0.22 AF reported in 2020. This unit demand factor is utilized in projecting demands through 2040.

Institutional/ Governmental: Institutional and governmental demands averaged six percent of treated retail demands for the period 2014 through 2020. Total use per connection for the same period averaged 4.70 AFY/connection. This unit demand factor is utilized in projecting demands through 2040.

Landscape: Dedicated landscape connections are utilized by various NID customers, including residential and non-residential commercial customers. Landscape water use averaged 2.5 percent of total treated retail use for the period 2014 through 2020. Total use per connection averaged 1.70 AFY/connection. This unit demand factor is utilized in projecting demands through 2040.

Other: The “other” category includes meters dedicated to fire services. Accordingly, this category averaged less than one percent of retail treated demands for the period 2014 through 2020 as water is only used for fire system testing and actual fires. It is believed some of these fire systems are being connected to in-house toilets to allow system flushing, which would increase demands if conducted regularly. NID will continue to monitor total demands for this connection category and update projections as necessary. The average usage per connection is 0.04 AFY/connection. This unit demand factor is utilized in projecting demands through 2040.

Table 3-1. Treated Water Retail Customer Historical Demands (AF)

Service Area	2014	2015	2016	2017	2018	2019	2020
Single Family	6,125	5,029	5,306	5,748	5,951	5,793	6,429
Multi Family	672	555	597	658	609	598	636
Commercial	778	708	700	761	825	814	759
Industrial	0	0	0	0	0	0	0.22
Institutional/ Governmental	523	393	406	459	511	520	476
Landscape	207	146	169	193	206	207	222
Other	19	17	19	20	22	23	28
Total:	8,324	6,848	7,197	7,839	8,124	7,955	8,550

3.1.2 Treated Water Wholesale Customers

NID serves treated water through master meters to wholesale customers per each respective agreement. Each customer agreement, historical usage, and projection assumptions are provided below and summarized in Table 3-2.

City of Grass Valley: NID provides treated water to the Broadview Heights area of Grass Valley. The water is metered through a master meter that NID then bills to Grass Valley. An agreement between the District and City of Grass Valley, dated April 2013, allows for supply as needed and as available from NID. The City of Grass Valley did not provide demand projections for this connection for the UWMP. The District assumes a future demand of 90 AFY, based on past usage, for the demand projections.

Lake Vera Mutual Water Company: NID provides treated water to Lake Vera Mutual Water Company. The water is metered through a master meter that NID then bills to the company. An agreement between the District and Lake Vera Mutual Water Company, dated June 1995, allows for

supply as needed from NID. As seen in Table 3-2, this demand has been increasing since 2014. The District assumes a future demand of 25 AFY for the demand projections.

Table 3-2. Treated Water Wholesale Customer Historical Demands (AF)

Service Area	2014	2015	2016	2017	2018	2019	2020
Grass Valley	65	65	53	75	74	37	86
Lake Vera Mutual Water Co.	14	16	18	18	22	24	22
Total:	79	81	71	93	96	61	108

3.1.3 Raw Water Wholesale Customers

NID provides raw water to wholesale customers per each respective agreement. Each customer agreement, historical usage, and projection assumptions are provided below and summarized in Table 3-3.

City of Grass Valley: NID sells surplus raw water to the City for use in their water treatment plant. Grass Valley operates a water treatment and distribution system, and is provided surplus raw water by NID. The agreement between the District and City of Grass Valley, dated April 2013, allows for supply as available from NID, there is no volume requirement. The City of Grass Valley did not provide demand projections for this supply for the UWMP. As seen in Table 3-3, this demand varied by approximately 200 AFY over the last six years. The District assumes a future demand of 1,000 AFY for the demand projections.

Nevada City: NID sells surplus raw water to Nevada City for use in their water treatment plant. Nevada City operates a water treatment and distribution system, and is provided surplus raw water by NID. The agreement is executed annually, with the annual volume to be delivered not exceeding 800 AFY. For the period 2014 through 2020, annual deliveries averaged approximately 260 AFY. During 2020, a total of 507 AF of raw water was delivered to Nevada City, marking the largest amount delivered from 2014 through 2020. The raw water is sold to Nevada City only if surplus to NID’s needs, and the upper limit of 800 AFY is not a required supply delivery. Nevada City did not provide projected supply needs for this UWMP. For conservative projections purposes, this UWMP assumes a projected demand of 500 AFY for the future, to reflect the most recent 2020 demands.

Nevada City – School of Arts (raw water): The Nevada City School of Arts (formerly Bitney Springs LLC) is supplied raw water for on-site treatment and redistribution. The deliveries have been made in the past pursuant to an agreement since 1991, and is separate from the annual agreement with Nevada City (described above). As seen in Table 3-3, historical use has ranged from 5 to 7 AFY for the period 2014 through 2020. NID is contracted to provide up to 36 AFY for the School of Arts. Although the School of Arts has yet to exercise the full contractual amount, projected demands reported in this UWMP incorporate NID’s contractual amount of 36 AFY.

Lincoln/PCWA: NID sells raw water to the Placer County Water Agency (PCWA) for treatment and subsequent delivery to customers within NID’s service area located in the City of Lincoln. The demands associated with these customers ranged from 571 to 1,650 AFY for the period 2014 through 2020. The low usage in 2016 was likely due to the City’s groundwater use. The City of

Lincoln provided NID with projected treated water demands for the NID service area within the City of Lincoln and these are used in the demand projections further below.

Table 3-3. Raw Water Wholesale Customer Historical Demands (AF)

Service Area	2014	2015	2016	2017	2018	2019	2020
Nevada City	299	254	187	267	214	114	507
Grass Valley	1,005	916	942	957	1,041	842	862
Nevada City School of Arts	5	5	5	5	6	7	5
Lincoln/PCWA	1,640	1,498	571	1,349	1,430	1,244	1,517
Total:	2,949	2,673	1,705	2,578	2,691	2,207	2,891

3.1.4 Raw Water Retail Customers

NID provides raw water to customers during three time-periods; (1) during the irrigation season (April 14 – October 15); (2) Fall/Winter period; and (3) annually. As described in Chapter 2, the Fall/Winter and annual customers are a subset of the irrigation season customers, as required by NID.

Actual raw water customer usage is difficult to quantify on an individual basis as customers order a maximum volume of water, but the actual amount diverted is based on customer practices. The raw water system infrastructure is used throughout NID to deliver water to raw water customers, water treatment plants, and wholesale customers, as well as incurring water loss, further complicating the quantification of actual retail raw water use. To maintain proper flow in the canals to ensure adequate delivery, the District supplies the canals with more water than actually ordered by customers. This “carriage water” is picked up by other canal systems or lost to the District. While the carriage water is not necessarily a consumptive demand, it is required to maintain ability to supply customers’ ordered amounts, and is therefore built into the water demands. For the purposes of this UWMP, total supply required to serve raw water customers (total duty) is assumed to be the total volume diverted into the raw water system minus the water treatment plant and wholesale deliveries. Raw water system loss, including carriage water, seepage, evaporation, stockwater, theft, and other unknown uses, is therefore included in the total raw water retail customer duty. Table 3-4 presents the calculated customer duty from ~~2015~~2014 through 2020. This duty is divided by number of raw water customers to develop a proxy unit duty per raw water customer connection. Table 3-5 presents the amount of irrigation season, Fall/Winter, and annual water orders for comparison. The ordered amount in miner’s inch is converted to volume assuming continuous flow over each respective time period. As stated earlier, the actual amount used is unknown as each customer manages their own raw water use strategies. However, comparing the amount ordered to the actual water duty provides a planning level correlation for future projections.

Table 3-4. Raw Water Customer Duty

NID Raw Water Customers	2014 AF	2015 AF	2016 AF	2017 AF	2018 AF	2019 AF	2020 AF
Total diverted into canals	140,447	132,452	133,682	136,219	144,786	141,482	152,947
- Water Treatment Plant Deliveries	(9,826)	(8,521)	(8,942)	(9,752)	(10,061)	(9,269)	(10,537)
- Raw Water Wholesale Deliveries	(1,309)	(1,175)	(1,134)	(1,229)	(1,261)	(963)	(1,374)
- PCWA/Lincoln Deliveries	(1,640)	(1,498)	(571)	(1,349)	(1,430)	(1,244)	(1,517)
Total raw water customer duty:	127,672	121,258	123,035	123,889	132,034	130,006	139,519
Raw water customer unit duty factor – AF/customer ¹	25.4	24.0	24.0	23.9	25.6	25.2	26.9

¹Unit duty factor divides total water duty by number of raw water customers listed in Table 2-3.

Table 3-5. Raw Water Customer Orders

NID Raw Water Customers	2014 AF	2015 AF	2016 AF	2017 AF	2018 AF	2019 AF	2020 AF
Irrigation Season	109,335	110,304	113,941	113,921	113,651	112,075	111,515
Fall/Winter	4,711	4,788	4,978	4,078	4,216	3,184	5,321
Annual	3,656	3,593	3,527	3,538	3,395	3,262	3,309
Total Orders:	117,702	118,685	122,446	121,537	121,262	118,521	120,145

A subset of the retail raw water customer accounts are mutual water companies. The District serves these companies on a retail customer basis without separate sales contracts. Therefore, the number of connections and subsequent demands are included in the retail raw water projections. Table 3-6 lists each mutual water company the District serves.

Table 3-6. Retail Raw Water Mutual Water Company Customers

Iron Mountain Mutual Water Company	Flying R Ranch Water Association
Melody Oaks Mutual Water Company	Footehold Estates Water Association
Mount Vernon Estates Mutual Water Company	Gold Blossom-Rivera MWA
Mustang Valley Mutual Water	Greenpeace Water Association
Ophir Prison Estates Mutual Water	HDA Association
Ridge View Woodlands Mutual Water Company	Little Greenhorn Creek Water Association
Rough & Ready Ranch Estates Mutual Water Company	Meadow Hill Water Association
Running Water Inc.	Moonshine Water Company
Sierra Foothills Water Association	Oakcreek Water Association
Sky Pines Mutual Water Association	Perimeter Road Pipeline
Ali Lane Mutual Water Association	Quail Hill Acres Road
Big Oak Valley Mutual Water	Redbud Water Association
Blackford Ranch Water Association	Rudd Road Pipeline Association
Carmody Special Water District Company	6 B Estates Water Association
Chicago Park Water Association	Saddleback North Water Group
Chili Hill Farms Water Association	Saddleback Water Association
Clear Creek Water Association	Streeter Road Water Association
Cole Country Water Users Association	Vian Water Association
Countryside Ranch Water Association	Wilkes Pipeline Association
Fawn Hill Drive Water Association	

Other Water Sales

South Sutter Water District (raw): In years when there is a surplus of the District’s wholesale water supply (described in Chapter 4) the District has sold some of the surplus supply to the South Sutter Water District (SSWD). Although this water sale occurred in 2011 through 2013, limited water was available to sell to SSWD, and only occurred in two months during 2016. For planning purposes, this UWMP projects a total of 0 AFY to be provided to the SSWD, although this water demand is subject to availability of future surplus supplies.

Out of Area Sales: In years of surplus water availability, the District provides water service to a small number of customers outside the service area boundaries. As of 2005, the District does not allow the establishment of any new outside District services, but recognizes those established before the 2005 cutoff when surplus is available.

3.2 Water Loss

Treated system loss includes losses associated with deliveries to retail and wholesale customers. The water loss includes water used for operational tasks such as system flushing, tank draining, as well as water lost to system leaks and meter inaccuracies. The District’s treated system loss is annually audited and validated in accordance with American Water Works Association (AWWA) standards. Upon validation, the audit is submitted to DWR. Although the validated water loss audit for 2020 has not been completed, 2020 water loss is estimated based on the difference in the metered effluent from the District’s water treatment plants and total treated water deliveries. Data for 2016 and 2017 is also estimated as the validated audit process began with 2018. This plan assumes a water loss of 10 percent in future projections as the District’s water loss reduction and non-revenue water programs are assumed to reduce losses over time. The ten percent loss factor is applied to projected treated deliveries to retail and wholesale customers.

Table 3-7. Treated Water System Total Water Loss

	2016	2017	2018	2019	2020
Treated Water Loss (AF)	990	975	911	933	1,200
Treated water produced (AF)	8,404	9,124	9,387	8,611	9,858
Percent Loss	11.8	10.7	9.7	10.8	12.2

3.3 Environmental Instream Flow Requirements

The District’s water supplies are subject to environmental instream flow requirements as per its water rights and from the District’s Federal Energy Regulatory Commission (FERC) License No. 2266 (known as the Yuba-Bear Project). Instream flow requirements are flows the District must leave in the respective streams, using the District’s supplies. The current total instream flow requirement is 7,665 AFY. In order to ensure compliance, the District actually uses a total of 9,410 AFY to meet the instream requirement.

The FERC license expired in July 2013, though the new license has not yet been issued. Until the new license is issued, the District continues to operate under the older requirements. The new proposed environmental flow requirements have been identified through the relicensing process. The current proposed instream flows will be based on a water year type, ranging from Wet to Extremely Dry year conditions. Details of the environmental instream flow requirements can be accessed on the FERC relicensing website at <http://www.eurekasw.com/nid/default.aspx>.

A majority of these environmental instream flow requirements are not recoverable downstream by NID, and therefore represent a demand on NID’s total supplies. Table 3-8 presents the total unrecoverable volumes for each year type. These projected water demands associated with the new FERC requirements offer a high degree of uncertainty, as they depend on future water year types. For this UWMP, the range of potential demands are shown.

Table 3-8. Unrecoverable Environmental Flow Requirements by Water Year Type

Water Year Type	Unrecoverable Environmental Flow Requirement (AFY)
Wet	59,257
Above Normal	51,637
Below Normal	41,900
Dry	27,823
Critically Dry	22,674
Extremely Dry	16,359

3.4 Water Demand Projection Summary

Total treated and raw water demand projections for the period 2025 through 2040 are reported in Table 3-9 below. Normal year water demand projections are developed based on the customer type’s projected number of connections (see Chapter 2) and the unit factors (or other method) as described above. The unit factors include current water use savings from California Green Building Standards Code (CALGreen), Model Water Efficient Landscape Ordinance (MWELO), and Land Use Elements from the respective counties. The normal water year demand projections can be reduced during drought periods through the Water Shortage Contingency Plan presented in Chapter 6. Unrecoverable environmental instream flow requirements are reported as a range and assume the FERC license will be issued by 2025. Although the District currently over-supplies the current environmental instream requirements by approximately 20 percent to ensure compliance, the future license unrecoverable instream flows are projected as listed, without any over-supply. The District should revisit this assumption once the license is finalized and implementation is started. Total 2040 projected demands with the current 7,665 AFY unrecoverable flows is approximately ~~499~~166,000 AF, versus ~~499~~175,000 AF- ~~242~~218,000 AF with the new FERC license.

Table 3-9. Projected Water Demands by Customer Type

Service Area	2020 AF	2025 AF	2030 AF	2035 AF	2040 AF	2040 % increase over 2020
NID Treated Water Customers						
Single Family	6,429	6,567	6,705	6,842	6,980	9%
Multi Family	636	640	661	683	705	11%
Commercial	759	802	826	850	874	15%
Industrial	0.22	0.22	0.22	0.22	0.22	0%
Institutional/ Governmental	476	499	518	538	557	17%
Landscape	222	230	251	272	294	32%
Other	28	34	43	51	59	114%
NID Treated Wholesale						
Grass Valley	86	90	90	90	90	5%
Lake Vera Mutual Water Company	22	25	25	25	25	12%
Treated Subtotal:	8,658	8,887	9,119	9,351	9,584	11%
Water Loss	1,200	889	912	935	958	-20%
Total Treated:	9,858	9,775	10,031	10,287	10,542	7%
NID Raw Water Customers						
Raw Water Customer Duty	139,519	<u>132,885</u> 137,968	<u>136,073</u> 147,510	<u>139,260</u> 157,051	<u>142,447</u> 166,593	<u>2%</u> 19%
NID Raw Water Wholesale						
Nevada City	507	500	500	500	500	-1%
Grass Valley	862	1,000	1,000	1,000	1,000	16%
Nevada City School of Arts	5	36	36	36	36	626% ²
To PCWA for Lincoln	1,517	2,240	2,695	3,297	3,898	157%
Total Raw Water:	142,410	<u>136,661</u> 144,744	<u>140,304</u> 151,741	<u>144,093</u> 161,884	<u>147,881</u> 172,027	<u>4%</u> 21%
Environmental Instream Requirements						
Unrecoverable Flows	7,665 ¹ (9,410)	16,359-59,527	16,359-59,527	16,359-59,527	16,359-59,527	113% - 533%
Total Water Demands:	161,678	<u>162,795 -</u> <u>205,963</u> 167,879 <u>-211,047</u>	<u>166,693 -</u> <u>209,861</u> 178,131 <u>-221,299</u>	<u>170,738 -</u> <u>213,906</u> 188,530 <u>-231,698</u>	<u>174,783 -</u> <u>217,951</u> 198,928 <u>-242,096</u>	<u>8% -</u> <u>35%</u> 23% <u>-50%</u>

¹ The 2020 instream requirement is 7,665 AF, but NID diverted 9,410 AF to ensure compliance. 9,410 AF is used in the Total Water Demands calculation.

² Nevada City School of Arts demand projection lists the maximum supply per the contract obligations.

Table 3-10 presents the summarized demands from Table 3-9 into retail and wholesale customers, and unrecoverable environmental flows. It should be noted that demand projections represent an average, and it is expected that demands will fluctuate from year to year. The Plan for Water process will further investigate annual fluctuations to develop potential ranges that can be used for triggering points to invoke alternative water resource management strategies.

Table 3-10. Summarized Projected Water Demands (AFY)

Demand Type	2020	2025	2030	2035	2040
Retail ¹	149,269	<u>142,545</u> <u>147,629</u>	<u>145,988</u> <u>157,426</u>	<u>149,431</u> <u>167,223</u>	<u>152,875</u> <u>177,020</u>
Wholesale	2,999	3,891	4,346	4,948	5,549
Unrecoverable Environmental	9,410	16,359-59,527	16,359-59,527	16,359-59,527	16,359-59,527
Total	161,678	<u>162,795 -</u> <u>205,963</u> <u>167,879</u> <u>-211,047</u>	<u>166,693 -</u> <u>209,861</u> <u>178,131</u> <u>-221,299</u>	<u>170,738 -</u> <u>213,906</u> <u>188,530</u> <u>-231,698</u>	<u>174,783 -</u> <u>217,951</u> <u>198,928</u> <u>-242,096</u>

¹Retail includes treated customers, raw water customers, and all system losses.

3.5 Reliability Analysis Water Demand Projection

Demand projections are modified for use in the supply reliability analysis in Chapter 5. The supply reliability compares supplies and demands during a normal hydrologic year, a single dry year, and a multi-year drought. Customer demand during a normal hydrologic year is assumed to be as reported in Table 3-9. As it represents average hydrology, the Unrecoverable Environmental flows during a normal year are assumed to vary between the Wet to Below Normal year types in Table 3-9. Table 3-11 presents the projected demands during a normal hydrologic year.

Table 3-11. Reliability Analysis Normal Year Demand Projections Water Demands (AFY)

Demand Type	2025	2030	2035	2040
Retail ¹	<u>142,545</u> <u>147,629</u>	<u>145,988</u> <u>157,426</u>	<u>149,431</u> <u>167,223</u>	<u>152,875</u> <u>177,020</u>
Wholesale	3,891	4,346	4,948	5,549
Unrecoverable Environmental	41,900 - 59,527	41,900 - 59,527	41,900 - 59,527	41,900 - 59,527
Total	<u>188,336 -</u> <u>205,963</u> <u>193,420</u> <u>-211,047</u>	<u>192,234 -</u> <u>209,861</u> <u>203,672</u> <u>-221,299</u>	<u>196,279 -</u> <u>213,906</u> <u>214,071</u> <u>-231,698</u>	<u>200,324 -</u> <u>217,951</u> <u>224,469</u> <u>-242,096</u>

¹Retail includes treated customers, raw water customers, and all system losses.

For the purposes of this analysis, it is assumed all demands increase ten percent during a dry year to account for increased irrigation and other uses earlier in the spring and later into the fall. For those wholesale contracts that include a maximum amount, the amount is not increased but remains as the maximum amount. The Unrecoverable Environmental flows during dry years are assumed to vary between Below Normal and Extremely Dry year types in Table 3-8. It is assumed dry year demands are the same for a single dry year and multiple dry years. Table 3-12 presents the projected demands

during dry years. These demands use subsequently used in the supply reliability analysis in Chapter 5.

Table 3-12. Reliability Analysis Dry Year Demand Projections Water Demands (AFY)

Demand Type	2025	2030	2035	2040
Retail ¹	<u>156,800</u> 162,392	<u>160,587</u> 173,168	<u>164,375</u> 183,945	<u>168,162</u> 194,722
Wholesale	4,277	4,777	5,439	6,100
Unrecoverable Environmental	16,359 - 41,900	16,359 - 41,900	16,359 - 41,900	16,359 - 41,900
Total	<u>177,436 -</u> <u>202,977</u> 183,028 <u>-208,569</u>	<u>181,723 -</u> <u>207,264</u> 194,304 <u>-219,845</u>	<u>186,173 -</u> <u>211,714</u> 205,743 <u>-231,284</u>	<u>190,621 -</u> <u>216,162</u> 217,184 <u>-242,722</u>

¹Retail includes treated customers, raw water customers, and all system losses.

3.6 Low Income Demand Projection

Lower income residential demands are included in the District’s demand projections. Based on the Housing Element of the Nevada County General Plan (Nevada County Table 8.14, 2019), 44 percent of the population are low income. These include very-low and low-income dwelling units which are up to 80 percent of the median income. For Placer County, 33 percent of the population is very low and low income (Placer County Housing Element Table 18, 2020). The majority of the lower income households are located in urban cities that are densely populated or the rural locations in the northeast part of the county where population density is low.

3.7 SBX7 Compliance

Pursuant to California Water Code (CWC) §10608.24(b), the District must demonstrate its 2020 water use met the GPCD target adopted in its 2015 UWMP. As set forth in the 2015 UWMP, the District’s 2020 GPCD target was established as 197 GPCD, derived as the “gross water use” divided by the population during a defined baseline period, and reduced pursuant to one of four methods defined under California Water Code Section 10608.20(b). The District’s 2020 actual GPCD must use the same methodology to derive “gross water use” for 2020, then divide by the estimated 2020 population presented in Chapter 2.

As presented in the CWC, gross water use means, “the total volume of water, whether treated or untreated, entering the distribution system of an urban retail water supplier (§10608.12). This value corresponds to the total water diverted into the District’s water treatment plants during 2020. NID’s gross water use during 2020 was 40,537~~9,858~~ AF, and represents both the customer deliveries from the District’s WTPs and the distribution system water loss. As shown in Table 2-5, the District’s population in 2020 was estimated to be 52,733. This results in a calculated 2020 compliance value of 478~~167~~ GPCD, which is less than the established target. Thus, the District is in compliance with CWC Section 10608.24(b) and has met its 2020 GPCD Target. The District’s compliance status for 2020 requirements are presented in Table 3-13 below.

Table 3-13. Demonstration of Compliance with 2020 GPCD Target

2020 Gross Water Use	<u>40,5379,858</u> AF
2020 Population	52,733
2020 Actual GPCD	<u>478-167</u> GPCD
2020 Target GPCD	197 GPCD
Compliance Achieved?	YES

4 Water Supply Characterization

This section describes sources of available water, quantities, and future sources of water. In addition, this section presents possible impacts to supply availability due to climate change.

4.1 Surface Water Supply

The District's primary source of supply is local surface water derived principally from the Yuba River, Bear River, and Deer Creek watersheds that is diverted and stored under the Districts pre-1914 and post-1914 appropriative water rights. The water rights allow for diversion and/or storage of approximately 450,000 AF per year (AFY). Because of hydrologic variability and temporal water rights limitations, NID does not regularly exercise the full allotment of 450,000 AFY. The District has an extensive system of storage reservoirs that provides surface water supply to the District's six water treatment plants as well as to the raw water customers. The District also maintains a contract with PG&E to purchase surface water that originates from the same supply sources as the District water rights supply.

4.1.1 Water Rights

The District was originally organized for the purpose of storing and delivering irrigation water to farmers and ranchers. In the early 1920's the District acquired storage and regulating facilities in the upper reaches of the Middle and South Yuba Rivers. In 1926, the District acquired most of its Canyon Creek holdings including the Bowman, Sawmill, French, and Faucherie Reservoirs. Associated water rights were also obtained. Deer Creek water rights were obtained in the 1920's for the development of Scott's Flat Reservoir. The District's surface water supply water rights are divided into two main categories:

- Direct Diversions
- Diversions to Storage

Direct Diversions. This supply includes water rights to runoff from the District's watershed. Watershed runoff is the District's primary water supply. The amount of runoff and the manner in which it is used depends upon the amount of water contained in the snowpack and the rate at which the snowpack melts. District water rights include 22 pre-1914 rights acquired from mining interests, along with 28 post-1914 rights filed with the State of California to provide for domestic, municipal, industrial, recreational, power, and irrigation uses, and three riparian rights. These include rights for both consumptive and power purposes. The total water right volumes consist of storage rights, direct diversion rights, and some are a combination of both. The total quantity estimated for direct diversions and diversions to storage under current consumptive water rights is approximately 450,000 AF on an annual basis.

The system of storage reservoirs and conduits used to transport water to the District's service area boundary is referred to as the Upper Division. The Upper Division is operated in conjunction with PG&E under the terms of a joint agreement. Average runoff from the Upper Division watershed, including the watershed area feeding Scotts Flat Reservoir, is approximately 232,600 AFY. Over the last 30 years runoff has fluctuated from less than 78,000 AF in a dry year (2015) to over 541,100 AF in wet years (2017).

Due to provisions in the PG&E Coordinated Operations Agreement, hydrologic variability, and the fact that the District is not the senior water right holder, the historical runoff data evaluated to estimate the District's average runoff supply does not include supplies from the Bear River and the South Yuba River. The District is likely to receive some water from the Bear River and South Yuba River sources in dry years. Due to the uncertainty of the amount of supply available from these two sources, it has not been quantified in this UWMP. NID's Plan For Water process will investigate methods to track and monitor available runoff from the Bear and South Yuba Rivers.

The District's Yuba-Bear Project's Federal Energy Regulatory Commission (FERC) license (No. 2266) expired in July 2013. The Project is presently undergoing relicensing. The current proposed license includes increased environmental flow requirements, which reduces supply available to meet customer demands as discussed in Chapter 3.

Diversions to Storage. The second largest component of District's supply is diversions to storage, which contribute to the volume of water left in storage reservoirs at the end of the irrigation season, usually at the end of September. The District's main storage reservoirs can contain a maximum of 280,085 AF of water. Per the District's Water Shortage Contingency Plan, carryover storage should be held at a level not less than 78,000 AF. This includes a total 33,800 AF of minimum pool requirements reserved for environmental needs (not including new pending FERC requirements) and dead storage volume (includes siltation estimates) that cannot be counted upon as a supply resulting in an available storage capacity of 202,085 AF. As with most reservoirs, the District's reservoirs are slowly being filled with sediment. Through the District's Plan For Water process, the District will continue to monitor and consider removal of sediment from the District's reservoirs as a supply enhancement strategy.

The water supply is dependent on snowmelt and rain to fill storage reservoirs, and the District manages its system based on the timing of those events. While there is some natural runoff during normal summer months, the irrigation season (April 15–October 14) demand is met primarily with withdrawals from storage reservoirs. Careful management and operation of the storage reservoirs is required to capture the maximum amount of runoff, minimizing spillage from the reservoirs, through the variable spring snow melt season. Carryover storage is also affected by Winter/Fall customer demands. Fall water deliveries effectively use carryover storage, meaning less water could be available for the following irrigation season.

As part of NID's water supply strategy aimed at maintaining a reliable supply, a storage carry-over target is utilized. The end of September target amount of 130,000 AF is determined as 75 percent of historical end of September average. This storage within the District's supply reservoirs is used as a basis for identifying a water supply shortage (see Chapter 6 – Water Shortage Contingency Plan). The target is used by the District to identify necessary operational and strategic changes the District may employ in maintaining reliable supplies to meet expected customer demands. Carry-over storage supplies are relied upon by the District in meeting demands, including raw and treated water demands. It is anticipated that this water will also be utilized in meeting future FERC requirements during dry-months, as the natural portion of watershed runoff during this period may be insufficient.

4.1.2 Purchased or Imported Water

The hydropower potential of its water led the District to enter into an agreement with PG&E in 1924 to use of a portion of the District's water through PG&E facilities. At the same time the District secured the option to purchase PG&E water to augment its own supply. Over the years, this agreement has been modified to meet the changing conditions and requirements of both organizations. In 1963, the District and PG&E agreed to develop additional storage capacity on both Middle Yuba and the Bear River.

The PG&E contract has recently been renewed. The maximum amount available for District purchase is 54,361 AF with reductions based on the Sacramento Valley Index (SVI). However, purchase is only available in monthly allotments in which many of the months are during the winter, when the District would not need the supply. For planning purposes, the District assumes 7,500 AF is available on an average basis.

4.2 Groundwater

Most of the Sierra Nevada foothills located in the District's service area have a fractured rock groundwater system (CABY, 2020), including granitic and metavolcanic (USGS, 1984). NID views the fractured rock groundwater system as low yielding and unreliable for a District supply source. The District does not utilize groundwater as an existing or planned source of water supply or recharge due to limited groundwater availability. The majority of the District's service area has no groundwater aquifer per California Department of Water Resources Bulletin 118 with the exception of the very small portion of the District's service area in Lincoln, which is on the eastern boundary of the Sacramento River Basin, North American Sub-Basin. Although NID has no groundwater facilities and does not use groundwater, NID is a member of the local groundwater sustainability agency, the West Placer Groundwater Sustainability Agency. NID is aware there are private wells in the area used for domestic purposes, but NID does not track private groundwater well inventory or use at this time.

4.3 Stormwater

The District currently has a policy to not actively collect stormwater runoff as presented in the current stormwater policy (District Policy #6655). However, based on current system configurations, the District may incidentally divert stormwater into the canal system due to uncontrolled runoff outside of NID's control.

4.4 Wastewater and Recycled Water

Municipal recycled water is municipal wastewater that has been treated to a specified quality to enable it to be used again for beneficial purposes. For the purpose of this UWMP recycled water means only municipal recycled water, that is, water that has been treated and discharged from a municipal wastewater facility. This subsection describes the wastewater collection, treatment, and disposal and recycled water coordination within the District's water service area.

4.4.1 Wastewater Collection, Treatment, and Disposal

Wastewater collection, treatment, and discharge in the District's service area is the responsibility of Nevada City, Grass Valley, and Auburn. The District has no authority or control over wastewater management in the District's service area. The District understands that reuse is an important element of integrated water supply planning and is open to investigations with any of the wastewater utilities to support further development of a reuse supply component.

Municipal wastewater is generated within the District from a combination of residential and commercial sources. The wastewater is collected by gravity and force mains in a series of main, trunk, and interceptor sewers owned and operated by the three municipalities within the District service area: the City of Grass Valley, Nevada City, and the City of Auburn. The wastewater treatment and discharge within the service area in 2020 is shown in Table 4-2. The District's use of recycled water within the service area is based on the April through October total effluent from the WWTPs.

- **City of Grass Valley:** The City of Grass Valley operates a tertiary wastewater treatment plant, and is permitted for treating 2.78 mgd. Grass Valley maintains 55 miles of pipeline within the collection system and six wastewater lift stations. Treated wastewater is discharged to Wolf Creek.
- **Nevada City:** Nevada City is permitted to collect and treat an average dry weather flow of 0.69 mgd. The plant went through a multi-million dollar upgrade which was completed in 2007. It is a tertiary treated activated sludge plant. The Nevada City Wastewater Treatment Plant's treated wastewater is discharged to Deer Creek.
- **City of Auburn:** The City of Auburn's treatment plant is located west of Auburn in the Ophir area. The plant is permitted to discharge its treated effluent into Auburn Ravine Creek to a maximum flow of 1.67 mgd. The effluent is treated to tertiary levels. The City of Auburn also maintains over 65 miles of wastewater collection lines throughout Auburn. This network of pipes collects sewage from residences and businesses within the City of Auburn and transports it to the treatment plant.

The amount of wastewater collected within NID's service area is reported as the influent of the three waste water treatment plants (WWTPs) listed in Table 4-1. Estimated wastewater flows generated within the District in 2020 are presented in Table 4-1. Table 4-2 lists the treatment and discharge volumes for 2020.

Table 4-1. Wastewater Collected within Service Area in 2020

Name of Wastewater Collection Agency	Metered or Estimated?	Volume of Wastewater Collected from UWMP Service Area 2020 (AF)	Name of Wastewater Treatment Agency Receiving Collected Wastewater	Treatment Plant Name	Is WWTP Located within UWMP Area?
City of Grass Valley	Estimated	1,553	City of Grass Valley	Grass Valley Wastewater Plant	Yes
Nevada City	Estimated	511	Nevada City	Nevada City Wastewater Treatment Facility	Yes
City of Auburn	Estimated	1,429	City of Auburn	Auburn Wastewater Treatment Plant	Yes
Total		3,493	--	--	--

Table 4-2. Wastewater Treatment and Discharge within Service Area in 2020

Wastewater Treatment Plant Name	Discharge Location	Discharge Location Description	Method of Disposal	Does this plant treat wastewater generated outside of service area?	Treatment Level	Wastewater Treated (AF)	Discharged Treated Wastewater (AF) ¹	Recycled within Service Area (AF)	Recycled outside of service area ² (AF)
City of Grass Valley	Wolf Creek	Wolf Creek	River or creek outfall	Yes	Tertiary	1,553	1,466	673	--
Nevada City	Deer Creek	Deer Creek	River or creek outfall	Yes	Tertiary	511	386	187	--
City of Auburn	Auburn Ravine	Auburn Ravine	River or creek outfall	Yes	Tertiary	1,429	1,137	549	--
Totals³						3,493	2,989	1,408	

¹Information obtained from Grass Valley, Nevada City, and Auburn.

²Amount of recycled use outside of service area is not tracked by NID.

³Totals may not add due to rounding.

4.4.2 Recycled Water System Description

All wastewater treated within the District service area is discharged to local watercourses. Once discharged, the flow is available for appropriation by the District. Recycled water discharge mixes with District water being transported in those watercourses. The combined waters are then diverted from the creeks into canals. This supply of water augments the District’s overall water supply. The District uses recycled water exclusively for deliveries to the District’s raw water customers. Below is a description of the use of recycled water from each of the three wastewater treatment municipalities within the District service area.

The District utilizes recycled wastewater effluent from the Nevada City sewage treatment plant for raw water system customers through its diversion at Deer Creek. The District utilizes recycled sewage effluent from the Grass Valley sewage treatment plant for raw water system customers through its diversion at Wolf Creek. The District utilizes recycled sewage effluent from the Auburn sewage treatment plant for raw water system customers through its diversions located along Auburn Ravine.

4.4.3 Potential, Current, and Projected Recycled Water Uses

Due to current system configurations, potential uses for recycled water are limited to deliveries to raw water customers, and mainly occur during the summer months. There are no facilities in place to distribute recycled water to other customers or end-users. The District actively monitors the viability of such facility improvements as opportunities arise.

Table 4-3 presents the current and projected reuse water demands in the District’s service area. The extent to which recycled water is available in the future is dependent upon the capacity and regulatory environment of the three WWTPs, and the District’s current recycled water strategy. Recycled water supplies could potentially be reduced based on the assumption that discharges to natural waterways from the wastewater treatment facilities would be reduced. The projected recycled water supply assumes 2020 is representative of future conditions with respect to recycled water utilized by the District. The projected recycled water use reported in the table may not reflect the potential for increases originating from a change in the District’s current recycled water strategy. The amount of potential uses of recycled water is the five-year average of recycled water discharged by the WWTP’s.

Table 4-3. Recycled Water Direct Beneficial Uses within Service Area

Beneficial Use Type	Amount of Potential Uses of Recycled Water (AF) ¹	Level of Treatment	2020 (AF) ²	2025 (AF) ²	2030 (AF) ²	2035 (AF) ²	2040 (AF) ²
Irrigation	3,836	Tertiary	1,408	1,408	1,408	1,408	1,408

¹Amount of potential uses of recycled water based on average of total effluent for the period 2016 through 2020.

²Projected recycled use subject to change based on the District’s recycled water strategy.

Table 4-4 provides a comparison of recycled water use projected to occur in 2020 in the 2015 UWMP with the actual 2020 recycled water use. As seen in Table 4-4, the projected volume of recycled water utilized by the District was 2,321 AF while the actual use was 1,408 AF. The less

than anticipated recycled use may be attributed to less than projected effluent discharge during the irrigation season and the decommissioning of the Sewer Maintenance District (SMD) WWTP in 2016, which decreased the available supply to the District.

Table 4-4. 2015 UWMP Recycled Water Use Projection Compared to 2020

Beneficial Use Type	2015 Projection for 2020 (AF)	2020 Actual Use (AF)
Agricultural Irrigation	2,321	1,408

Note: 2015 Projections from Table 5-4 of NID’s 2015 UWMP

4.4.4 Actions to Encourage and Optimize Future Recycled Water Uses

The District does not have the authority or control to optimize the use of reclaimed water. Therefore, the District does not have an optimization reuse plan. The District utilizes recycled water to meet raw water demands exclusive of the potable distribution service area. This is more cost effective than the installation of a dual distribution system within its retail potable water system. Recirculating uses of water will continue to occur within the District service area. The District does not maintain incentives to use reclaimed water.

4.5 Desalinated Water Opportunities

The District has no sources of ocean water, brackish water, or groundwater that provide viable opportunities for development of desalinated water as a long term supply.

4.6 Water Exchange and Transfers

The District will consider the feasibility of water transfers on a short-term basis as opportunities arise. There were no exchanges or transfers from 2016 through 2020.

4.7 Future Water Projects

As a mostly rural area primarily dependent on its snowmelt-based supply, the District faces unique challenges in projecting its future supplies and demands. The character of the area and water management practices of the past may be different in the future. As such, the District is in the early stages of a long-term visioning and planning effort to better understand potential future conditions and needs, and identify management and operational practices to meet those needs. The process, Plan For Water, will identify optional water management practices as triggering points in supply, demand, regulatory, legal, and other events are reached. These practices may include supply projects, demand management efforts, policy changes, and others.

The District does anticipate studying the expansion of reservoir capacity as part of the Plan For Water process. Additional reservoir capacity would offer the District greater reliability with respect to dry-year supplies. In addition, recent climate modeling indicate a temporal shift in expected watershed runoff. The expanded reservoir capacity could be used to capture more runoff for subsequent use by the District.

Depending on growth, some of the District’s water treatment plants are expected to be expanded. Once capacity triggering points are neared, the District will begin the planning process for capacity expansion. The anticipated water treatment plant expansions are summarized in Table 4-5. This table also provides an estimated quantification of each project’s normal-year yield, single dry-year yield, and multiple dry-year yields. The WTP expansion projects do not increase the District’s raw water supply; however, they do increase the amount of treated water available for the District’s treated water customers.

Table 4-5. Expected Future Water Supply Projects or Programs

Name of Future Project/Program	Joint Project with other suppliers?	Planned Implementation Year ¹	Planned for Use in Year Type	Expected Increase in Water Supply to Supplier (AF) ²
Loma Rica WTP 4 mgd expansion	No	tbd	Average year/single-dry year/multiple-dry year	1,792
E. George WTP 6 mgd expansion	No	tbd	Average year/single-dry year/multiple-dry year	2,688
Lake Wildwood WTP 4 mgd expansion	No	tbd	Average year/single-dry year/multiple-dry year	1,792
North Auburn WTP 4 mgd expansion	No	tbd	Average year/single-dry year/multiple-dry year	1,792

¹ Planned implementation to be determined at a later date and depend on capacity requirements.

² The expected increase in water supply available as a result of the water treatment plant capacity is assumed to equal the expansion capacity divided by two.

4.8 Summary of Existing and Planned Sources of Water

The District’s primary supply comes from surface water, including watershed runoff and carryover storage. The District assumes purchased an average of 7,500 AFY of the PG&E supplies (HDR, 2020). The PG&E supply availability is subject to hydrologic variability and available District funding. As stated earlier, the projected recycled water supply assumes 2020 is representative of future conditions with respect to recycled water utilized by the District. A summary of actual supply sources and quantities in 2020 are provided in Table 4-6. The water supplies projected from 2020 through 2040 are provided in Table 4-7. Projected direct diversion and storage values are based on the year 2000 values as the assumed average year conditions.

Table 4-6. Water Supplies – 2020 Actual

Water Supply	Description	Actual Volume (AF)	Water Quality	Total Right/ Contract (AF)
Purchased Water	PG&E	0	Raw water	54,361
Surface Water	Watershed runoff	119,500	Raw water	450,000 ²
Surface Water	Carryover Storage	463,000 169,100 ¹	Raw water	
Recycled Water		1,408	Tertiary treated	as available
Total:		290,908 290,008	--	--

¹ End of ~~2020-2019~~ storage.

² Combined total of the District’s water rights.

Table 4-7. Water Supplies – Projected

Water Supply	Addition Detail on Water Supply	Reasonably Available Volume (AF)			
		2025	2030	2035	2040
Purchased Water ¹	PG&E	7,500	7,500	7,500	7,500
Surface Water ²	Watershed Runoff	233,066	233,066	233,066	233,066
Surface Water ³	Carryover Storage	143,968	143,968	143,968	143,968
Recycled Water ⁴	Tertiary treated	1,408	1,408	1,408	1,408
Total:		385,942	385,942	385,942	385,942

¹ Average year availability, subject to hydrologic conditions (HDR, 2020).

² Average year availability assumed as year 1989 conditions.

³ Average year availability assumed as year 1989 conditions.

⁴ Assumes 2020 recycled water supplies utilized by the District.

4.9 Special Conditions

Special conditions that may impact District supplies are presented in the following subsections, including climate change effects and regulatory conditions and project development.

4.9.1 Climate Change Effects

Climate change is increasingly at the forefront of water resource management discussions. The District’s snowpack-based supply and delivery strategy could be extensively impacted by changing temperatures and precipitation. As such, the District undertook an analysis of climate change impacts to future supplies. The analysis included projecting future hydrologic conditions and their potential effect on the District’s water supplies, specifically watershed runoff. The approach, State and Global Climate Model (GCM) datasets incorporated, assumptions, and results of the analysis are documented in the technical memorandum titled, “Hydrologic Analysis Technical Memorandum – Final Report” (HDR, 2020). The reader is referred to this reference for detailed description of the modeling effort and assumptions.

The modeling and analysis produced hydrologic data sets that represent historic and projected climate change condition for the year 2070 that can be used to quantify how much of the projected watershed runoff is available to be used as District water supply.

Table 4-8 presents the projected 2070 runoff values at four locations in the District’s watershed under the various climate scenarios compared to the historical average runoff at each location. Results from the modeling and analysis indicated that changes in runoff volume are not directly proportional to changes in precipitation volume between scenarios. Variation of temperature, rainfall intensity, and rainfall duration impact the projected runoff. The detailed monthly model results also indicated a shifting of runoff to earlier in the year, as is expected with predicted warmer temperatures.

Table 4-8. Percent of Average Annual Historic Runoff

Location	Percent of Average Annual Historical Runoff at Each Location		
	2070 DEW ¹	2070 Median	2070 WMW ²
Middle Yuba River at Milton Diversion Dam	92%	104%	126%
Canyon Creek at Bowman Dam	92%	104%	125%
Bear River at Rollins Dam	90%	109%	148%
Deer Creek at Scotts Flat Dam	90%	108%	147%

¹DEW – Drier, extreme warming scenario

²WMW – Wetter, moderate warming scenario

The analysis also evaluated runoff projections under drought condition. A five-year historic drought (1987-1991) was input into the hydrology, with results presented in Table 4-9. Note the projected runoff values are solely based on the hydrologic characteristics of the five-year drought selected, and a different five-year period will result in different results. Results indicate the watershed is significantly impacted in this drought condition, with runoff reducing up to 75 percent in the early drought period, and 50 percent in later drought period. The average year 2070 runoff projected in the hydrologic model (383,500 AF) includes additional subbasins that are not included in the Upper Division dataset that lists an average historical runoff of 232,600 AFY in Section 4.1.1.

Table 4-9. Projected Watershed Runoff during Historical Five-Year Drought (1987-1991)

2070 Projected Average Year Runoff, AF	Drought Year 1, AF	Drought Year 2, AF	Drought Year 3, AF	Drought Year 4, AF	Drought Year 5, AF
383,500	97,200	95,200	315,900	158,200	166,700

Projected runoff not necessarily available to the District due to temporal water rights restrictions and FERC in-stream flow requirements.

The annual precipitation as measured at the NID Bowman Lake rain gage from 1987 through 1991 is presented in Table 4-10.

Table 4-10. 1987-1991 Annual Precipitation - Bowman Lake Rain Gage

1987	1988	1989	1990	1991
45.5 in.	49.1 in.	62.4 in.	44.8 in.	54.0 in.

4.9.2 Climate Change Impacts

The modeling results indicate NID should expect changes to the existing runoff patterns. In addition to NID’s own supply and demand impacts, climate change could also affect NID with respect to state-wide needs and local agriculture.

As evidenced by the modeling results, runoff will be affected under the modeled climate conditions. However, the State’s water management strategies also rely heavily on snowpack. It is expected similar changes will affect state-wide supplies and operations. Resulting policies, regulations, and legal impacts could likely impact NID’s supply availability for local use.

Local climate change impacts will likely affect current supply source options. There are approximately 52,000 parcels in the District’s service area. Only approximately 25,000 receive NID treated or raw water. It is assumed the remaining 25,000 parcels are served by fractured rock wells or are undeveloped. A prolonged drought, or increased winter runoff could reduce the amount of water that percolates into the rock fractures, reducing the amount of fractured rock groundwater. This in turn could cause private wells to be insufficient for use. Failing wells will likely cause an increase in the NID customers and subsequent demands, as existing residences will need to connect to the water system. Some of these users may be too far from existing infrastructure making it potentially cost prohibitive to connect, however, the District does expect new customers in the “soft service areas”, which are areas near existing infrastructure.

Local climate changes could also affect the community’s long-standing agriculture presence. Changing temperatures and precipitation patterns could affect crop types and irrigation demands, open up higher elevations to plantings, affect crop yields, change agronomic practices, and others. Each of these will have an effect on NID supply requirements, operational strategies, and infrastructure requirements.

In addition to supply and demand issues, NID also expects impacts to its other responsibilities. Watershed impacts will affect forest management practices, implementation of the FERC license requirements, and increase catastrophic fire risk. Existing recreation opportunities may be altered or not available under certain conditions. Hydropower generation, which provides significant revenue to the District, may be shifted into less beneficial market pricing periods. Hydropower generation may also decrease as the normal high revenue summertime generation period may not have the water supply to generate as in the past.

Enhancing climate change resiliency is an important element for all levels of water resources planning across the state. The State is pursuing numerous avenues to quantify potential issues and develop mitigation alternatives. NID will follow these efforts and participate as available.

Regionally, groups of agencies and other stakeholders are also addressing these issues and developing mitigation efforts, such as American River Basin Study, Association of California Water Agencies Headwaters initiatives, and others. Locally, NID is committed to controlling its own water resources in a self-determining manner per its strategic plan. The Plan for Water is NID's vehicle to assess climate change impacts and develop and implement mitigation strategies and modifications to operate within climate change.

4.9.3 Regulatory Conditions and Project Development

Regulatory conditions and projects that may directly/indirectly impact District supplies include:

- Water Use Objectives
- Bay-Delta Plan Update
- State Water Resource Control Board (SWRCB) Mandatory Conservation Orders
- FERC Project No. 2266 Relicensing

It is anticipated that effects from these regulatory conditions and projects could impact the amount of supply available to the District, although the magnitude of such impacts are not yet fully understood. More information on each is presented below.

Water Use Objectives

The State DWR and SWRCB will develop and regulate water agencies to a Water Use Objectives, or water budget. The water budget will be built up from components such as residential indoor use, landscape irrigation, commercial and industrial targets, water loss limits, and other elements. Though currently the water agency will be regulated on the overall water budget, each component will be developed separately for each agency. The individual components have not yet been finalized, but current status is summarized below.

Residential indoor water use is set at 55 gpcd beginning in 2023. It will reduce to 52.5 gpcd from 2025 through 2029, and further reduce to 50 gpcd in 2030. Residential outdoor irrigation will be based on a DWR estimate of irrigated landscape and irrigation coefficients from the Model Water Efficient Landscape Ordinance (MWELO). Commercial, Industrial, Institutional, and other variances are still under development. It is noted, the State may impose residential indoor water use standards that are more prescriptive than presented above, pending additional legislation, regulatory actions, or executive order.

Water Agencies are to report annually their Water Use Objective performance starting in 2024. The SWRCB can begin issuing violation and corrective orders in 2026.

2006 Bay-Delta Plan Update

The 2006 Bay-Delta Plan Update is currently being developed by the SWRCB. Proposed changes have the potential to impact District surface water supplies. In general, the SWRCB is recommending new and modified flow requirements for the Sacramento River (and its tributaries), Delta interior flows and outflows, cold water habitat, and ecosystem protection. Information on the 2006 Bay-Delta Plan Update can be accessed at:

https://www.waterboards.ca.gov/waterrights/water_issues/programs/bay_delta/.

SWRCB Mandatory Conservation Orders and Water Rights Curtailment

In response to the California drought from 2014 through 2016, the Governor issued various executive orders that required mandatory conservation and curtailments on some water rights, including prohibitions on water waste and certain uses. Impacts to urban water suppliers included mandatory reduction in potable water production and submission of monthly monitoring reports.

The restrictions were imposed during the recent drought that occurred during 2014 through 2016. In 2015, the SWRCB required a 36 percent reduction from 2013 water use for treated water customers from May through September. Additionally, the SWRCB required a 33 percent reduction from 2013 water use during 2016. Further, NID was prohibited, based on priority, from exercising their water rights due to mandated curtailment. The District expects conservation and water rights curtailment orders in the future as well which will limit the amount of supply available and/or utilized to meet customer demands.

FERC Project No. 2266 Relicensing

The District is currently relicensing their Federal Energy Regulatory Commission (FERC) license (FERC Project No. 2266), which requires the District to maintain prescribed environmental in-stream flows at compliance points located throughout the service area. The current total water rights and FERC license environmental in-stream flow requirements is approximately 7,600 AFY and will increase substantially for most year types as described in Section 3.3. Most of these flows are unrecoverable by the District and therefore they represent a demand on the District’s supplies.

4.10 Energy Intensity

Among the statutory changes enacted with new requirements for 2020 UMWPs, an urban supplier shall include information it can readily obtain related to the energy use to produce, treat and deliver water. The energy intensity is defined as the net amount of energy required to deliver water supplies. Table 4-11 presents the District’s energy usage, volume entering the District’s WTPs, and resulting energy intensity for the period January 2018 through December 2018, considered to be representative of average usage.

The District recently implemented an energy generation and tariff strategy with PGE in which the District utilizes its renewable energy generated at the Scotts Flat Powerhouse to supply nearly all of the District’s energy needs.

Table 4-11. Energy Intensity (2018)

Year	Energy Usage (kWh)	Volume Entering Process, (AF)	Energy Intensity (kWh/AF)
2018	3,254,118	10,061	323

5 Water Supply Reliability and Drought Risk Assessment

Information on the District's supply and service reliability is presented in this section. Longer-term reliability is assessed using the Water Service Reliability Assessment, where drought conditions are assumed for over the planning horizon. Near-term reliability is assessed using the Drought Risk Assessment (DRA), which assumes the next five years are considered drought conditions.

5.1 Water Supply Reliability Assessment

The water service reliability assessment aims to report the District's ability to meet customer water demands under various conditions, including Normal Year, Single Dry, and Five-Consecutive-Year Drought scenarios. NID's assessment of water service reliability can be used to direct management actions, provide insight on funding allocations, and allows for project prioritization aimed at increasing service reliability under all scenarios. Constraints on water sources and a description of available management tools and options aimed at maximizing local resources is also included in the following subsections.

5.1.1 Constraints on Water Sources

Water supply reliability is an important component of the water management planning process. Factors contributing to inconsistency in the District's water supplies include legal limitations due to water rights and contracts limiting the quantity of water available to the District, regulatory and environmental constraints, and reductions in availability due to climatic factors. The surface water supply to the District is subject to reductions during single and multiple dry years (seasonal and climatic shortages). The District holds senior water rights to the majority of its supply and has the ability to manage carryover storage quantities based on domestic, municipal and irrigation needs.

Constraints on the District's water supply sources due to climate change and regulatory conditions are described in Section 4.9. Recent climate modeling indicates a temporal shift in the timing and duration of watershed runoff. Regulatory conditions that may impact the District's water supply include Water Use Objectives, the 2006 Bay-Delta Plan Update, SWRCB Mandatory Conservation Orders and Water Rights Curtailments, as well as the District's FERC Project No. 2266 Relicensing. Although these regulations have been identified to potentially affect NID's supply, the magnitude of each impact will vary between regulation and year types.

The District's contracted water supply from PG&E is dependent on the SVI, and therefore, is subject to reduction based on the Sacramento Valley Index (SVI).

Regulations governing drinking water quality with which the District must comply for its treated water supply are established at the Federal and State levels. One of those requirements is to prepare a Watershed Sanitary Survey every five years. As summarized in the District's 2017 Watershed Sanitary Survey Update (Starr Consulting et al., 2017) the District expects no loss of water used for urban purposes due to water quality impacts. The PG&E purchased water is similar in quality as the District's supply since it originates from the same sources and is co-mingled with the District supply.

The following primary observations were listed in the 2017 Watershed Sanitary Survey Update field assessment of the watershed. The District is able to address these potential raw water quality issues

through the treatment process at the water treatment plants. The District is placing a priority on converting open canals that convey water to a WTP to closed pipeline conveyances.

- Areas in the upper watersheds are, in general, minimally impacted by current human activities. However, previous mining era activities have had an impact.
- Current and historic mining operations distributed over large areas in the watersheds have a combined high potential to impact raw water quality.
- Marijuana cultivation chemicals and trash can impact raw water quality.
- During summer months, recreation in the upper watersheds, including body contact recreation, motorized recreation, camping, and hiking, bring large numbers of visitors into the area. This increases the potential for source water contamination.
- Major highways, local access roads, and railroads are located throughout the watersheds increasing the risks to source water quality.
- Various licensed pesticides and herbicides are used for weed control in and around the District's canals, however, during the application period, the treatment plants are bypassed.
- Most canals are open; they receive untreated drainage including influence from animals from the uphill slopes and are not protected from vandalism or other sources of contamination.

Natural disasters can also impact water quality. The quality of water supplies can be dramatically affected by fire. Storm damage to the District conveyance facilities may consist of the following elements:

- Damage to parts of canal intakes,
- Collapse or weakening of some sections of canal flumes,
- Erosion and sedimentation of, and landslides into, sections of the canals.
- Damage by falling trees
- Flying debris into the canals
- Filling of reservoirs by sediments through runoff

The above-listed damages can cause some temporary adverse water quality effects, and some short-term losses of the District's water supplies in extreme cases. Of greater concern to overall water quality are flood and precipitation related damage occurrences that could cause longer term adverse water quality impacts such as excessive runoff and loading of surface contaminants (such as livestock manure, petroleum products, pesticides, and mineral wastes).

The District's watershed runoff water supply sources are covered by a combination of pre-1914 water rights, post 1914- water rights, and riparian water rights. In some California watersheds including the Sacramento River watershed, drought has resulted in diversion curtailment orders being issued in 2014, 2015, and 2016 on water rights going back to a 1903 priority date.

5.1.2 Reliability by Type of Year

Reliability by year type addresses three hydrologic conditions. For consistency, the same years are selected for all supply sources. The normal year represents average supply availability. The year 1989 is selected as normal year based on historical watershed runoff data. 1977 is selected as the single dry year as it represents 19 percent of historic annual watershed runoff. The 1987-1991 drought is selected as the five-year consecutive drought as it represents recent watershed conditions and the variable drought conditions predicted throughout the state with climate change impacts.

Tables 5-1 through Table 5-3 display the District’s available supplies for a normal year (average), single-dry year, and a drought lasting five consecutive years. The PG&E Supply is subject to hydrologic conditions and available funding. The amount of watershed runoff utilized by the District is dependent on hydrologic and regulatory conditions. Carryover storage is dependent on hydrologic conditions to a degree and the District’s ability to manage the supplies in the reservoir system.

Table 5-1. Basis of Water Year Data (Reliability Assessment) – PG&E Supply

Year Type	Base Year	Volume Available (AF)	% of Average Supply
Average Year	1989	4,312	100%
Single-Dry Year	1977	19,464	451%
Consecutive Dry Years 1 st Year	1987	3,883	90%
Consecutive Dry Years 2 nd Year	1988	11,534	267%
Consecutive Dry Years 3 rd Year	1989	4,312	100%
Consecutive Dry Years 4 th Year	1990	1,672	39%
Consecutive Dry Years 5 th Year	1991	1,568	36%

These values represent supply that was purchased, not necessarily available. Volumes purchased are depending on many factors, including NID’s available budget at that time, projected needs, existing carryover storage, etc.

Table 5-2. Basis of Water Year Data (Reliability Assessment) – Watershed Runoff Supply

Year Type	Base Year	Volume Available (AF)	% of Average Supply
Average Year	1989	233,066	100%
Single-Dry Year	1977	44,387	19%
Consecutive Dry Years 1 st Year	1987	107,608	46%
Consecutive Dry Years 2 nd Year	1988	104,473	45%
Consecutive Dry Years 3 rd Year	1989	233,066	100%
Consecutive Dry Years 4 th Year	1990	126,866	54%
Consecutive Dry Years 5 th Year	1991	136,264	58%

Table 5-3. Basis of Water Year Data (Reliability Assessment) – Carryover Storage Supply

Year Type	Base Year	Volume Available (AF)	% of Average Supply
Average Year	1989	143,968	100%
Single-Dry Year	1977	27,956	19%
Consecutive Dry Years 1 st Year	1987	67,652	47%
Consecutive Dry Years 2 nd Year	1988	60,623	42%
Consecutive Dry Years 3 rd Year	1989	143,968	100%
Consecutive Dry Years 4 th Year	1990	125,658	87%
Consecutive Dry Years 5 th Year	1991	145,088	101%

Table 5-4 presents normal year anticipated supply and demand totals in five-year increments through 2040.

Table 5-4. Normal Year Supply and Demand Totals

Category	2025 AF	2030 AF	2035 AF	2040 AF
Supply Totals ¹	385,942	385,942	385,942	385,942
Demand Totals ²	<u>188,336 -</u> <u>205,963</u> <u>193,420</u> <u>-211,047</u>	<u>192,234 -</u> <u>209,861</u> <u>203,672</u> <u>-221,299</u>	<u>196,279 -</u> <u>213,906</u> <u>214,071</u> <u>-231,698</u>	<u>200,324 -</u> <u>217,951</u> <u>224,469</u> <u>-242,096</u>
Difference	<u>197,606 -</u> <u>179,979</u> <u>192,522</u> <u>-174,895</u>	<u>193,708 -</u> <u>176,081</u> <u>182,270</u> <u>-164,643</u>	<u>189,663 -</u> <u>172,036</u> <u>171,871</u> <u>-154,244</u>	<u>185,618 -</u> <u>167,991</u> <u>161,473</u> <u>-143,846</u>

¹From Table 4-7.

²From Table 3-11.

Table 5-5 presents the single dry year supply and demand totals in five-year increments through 2040.

Table 5-5. Single Dry Year Supply and Demand Comparison

Category	2025 AF	2030 AF	2035 AF	2040 AF
Supply Totals ¹	91,807	91,807	91,807	91,807
Demand Totals ²	<u>177,436 -</u> <u>202,977</u> <u>183,028</u> <u>-208,569</u>	<u>181,723 -</u> <u>207,264</u> <u>194,304</u> <u>-219,845</u>	<u>186,173 -</u> <u>211,714</u> <u>205,743</u> <u>-231,284</u>	<u>190,621 -</u> <u>216,162</u> <u>217,181</u> <u>-242,722</u>
Difference	<u>(85,629) -</u> <u>(111,170)</u> <u>(91,221)</u> <u>-(116,762)</u>	<u>(89,916) -</u> <u>(115,457)</u> <u>(102,497)</u> <u>-(128,038)</u>	<u>(94,366) -</u> <u>(119,907)</u> <u>(113,936)</u> <u>-(139,177)</u>	<u>(98,814) -</u> <u>(124,355)</u> <u>(125,374)</u> <u>-(150,915)</u>

¹Total of each supply from Tables 5-1, 5-2, and 5-3.

²From Table 3-12.

Table 5-6 presents the multiple dry year supply and demand totals in five-year increments through 2040.

Table 5-6. Multiple Dry Years Supply and Demand Comparison

Category		2025	2030	2035	2040
First Year	Supply Totals ¹	179,143	179,143	179,143	179,143
	Demand Totals	<u>177,436 -</u> <u>202,977</u> <u>483,028</u> <u>-208,569</u>	<u>181,723 -</u> <u>207,264</u> <u>494,304</u> <u>-219,845</u>	<u>186,173 -</u> <u>211,714</u> <u>205,743</u> <u>-231,284</u>	<u>190,621 -</u> <u>216,162</u> <u>217,181</u> <u>-242,722</u>
	Difference	<u>1,708 -</u> <u>(23,834)</u> <u>(3,885)</u> <u>-(29,426)</u>	<u>(2,580) -</u> <u>(28,121)</u> <u>(15,161)</u> <u>-(40,702)</u>	<u>(7,030) -</u> <u>(32,571)</u> <u>(26,600)</u> <u>-(52,141)</u>	<u>(11,478) -</u> <u>(37,019)</u> <u>(38,038)</u> <u>-(63,579)</u>
Second Year	Supply Totals ¹	176,630	176,630	176,630	176,630
	Demand Totals	<u>177,436 -</u> <u>202,977</u> <u>483,028</u> <u>-208,569</u>	<u>181,723 -</u> <u>207,264</u> <u>494,304</u> <u>-219,845</u>	<u>186,173 -</u> <u>211,714</u> <u>205,743</u> <u>-231,284</u>	<u>190,621 -</u> <u>216,162</u> <u>217,181</u> <u>-242,722</u>
	Difference	<u>(806) -</u> <u>(26,347)</u> <u>(6,398)</u> <u>-(31,939)</u>	<u>(5,093) -</u> <u>(30,634)</u> <u>(17,674)</u> <u>-(43,215)</u>	<u>(9,543) -</u> <u>(35,084)</u> <u>(29,113)</u> <u>-(54,654)</u>	<u>(13,991) -</u> <u>(39,532)</u> <u>(40,554)</u> <u>-(66,092)</u>
Third Year	Supply Totals ¹	381,346	381,346	381,346	381,346
	Demand Totals	<u>177,436 -</u> <u>202,977</u> <u>483,028</u> <u>-208,569</u>	<u>181,723 -</u> <u>207,264</u> <u>494,304</u> <u>-219,845</u>	<u>186,173 -</u> <u>211,714</u> <u>205,743</u> <u>-231,284</u>	<u>190,621 -</u> <u>216,162</u> <u>217,181</u> <u>-242,722</u>
	Difference	<u>203,911 -</u> <u>178,370</u> <u>198,319</u> <u>-172,778</u>	<u>199,623 -</u> <u>174,082</u> <u>187,042</u> <u>-161,501</u>	<u>195,173 -</u> <u>169,632</u> <u>175,603</u> <u>-150,062</u>	<u>190,725 -</u> <u>165,184</u> <u>164,165</u> <u>-138,624</u>
Fourth Year	Supply Totals ¹	254,196	254,196	254,196	254,196
	Demand Totals	<u>177,436 -</u> <u>202,977</u> <u>483,028</u> <u>-208,569</u>	<u>181,723 -</u> <u>207,264</u> <u>494,304</u> <u>-219,845</u>	<u>186,173 -</u> <u>211,714</u> <u>205,743</u> <u>-231,284</u>	<u>190,621 -</u> <u>216,162</u> <u>217,181</u> <u>-242,722</u>
	Difference	<u>76,761 -</u> <u>51,220</u> <u>71,169</u> <u>45,628</u>	<u>72,473 -</u> <u>46,932</u> <u>59,892</u> <u>34,351</u>	<u>68,023 -</u> <u>42,482</u> <u>48,453</u> <u>22,912</u>	<u>63,575 -</u> <u>38,034</u> <u>37,015</u> <u>11,474</u>
Fifth Year	Supply Totals ¹	282,920	282,920	282,920	282,920
	Demand Totals	<u>177,436 -</u> <u>202,977</u> <u>483,028</u> <u>-208,569</u>	<u>181,723 -</u> <u>207,264</u> <u>494,304</u> <u>-219,845</u>	<u>186,173 -</u> <u>211,714</u> <u>205,743</u> <u>-231,284</u>	<u>190,621 -</u> <u>216,162</u> <u>217,181</u> <u>-242,722</u>
	Difference	<u>105,485 -</u> <u>79,944</u> <u>99,893</u> <u>74,352</u>	<u>101,197 -</u> <u>75,656</u> <u>88,616</u> <u>63,075</u>	<u>96,747 -</u> <u>71,206</u> <u>77,177</u> <u>51,636</u>	<u>92,299 -</u> <u>66,758</u> <u>65,739</u> <u>40,198</u>

¹Total of each supply from Tables 5-1, 5-2, and 5-3.

Table 5-4 indicates there is ample supply during normal hydrologic years. However, as shown in Tables 5-5 and 5-6, demand exceeds supplies during single dry year and multiple dry year scenarios. This illustrates the highly variable reliability of a snowpack-based supply system during drought

periods. There are numerous management and operational efforts available to NID to address supply shortfall during drought periods. Demand reductions, carryover storage strategies, system operational strategies, supplemental supplies, increased storage, and others are all options to evaluate in creating the District’s future water resources management supply strategy in the Plan for Water process.

5.2 Drought Risk Assessment

This subsection provides the approach for conducting NID’s Drought Risk Assessment (DRA). The near-term planning exercise is used to address the District’s ability to meet customer demands based on the assumption the next five years are considered drought conditions. Data used for conducting the DRA include projected supplies and demands 2021 through 2025. Projected supplies and demands are compared and used for identification of a supply shortage condition.

Similar to the drought analysis in Section 5.1, the dry year demands are assumed to be increased ten percent and the new environmental in-stream flow requirements associated with FERC Project No. 2266 are included. The simulated five-year drought assumes the same drought as utilized in Section 5.1. Table 5-7 presents the comparison of total supply and demand for the DRA.

Table 5-7. Five-Year Drought Risk Assessment

Category	2021 AF	2022 AF	2023 AF	2024 AF	2025 AF
Total Water Use	173,770 - 199,311	176,084 - 201,625 <u>174,686 -</u> <u>200,227</u>	<u>175,603 -</u> 201,144 178,398 -203,939	<u>176,519 -</u> 202,060 180,713 -206,254	<u>177,436 -</u> 202,977 183,028 -208,569
Total Supplies	179,143	176,630	381,346	254,196	282,920
Surplus/Shortfall w/o WSCP Action	5,373 - (20,168)	<u>1,944 -</u> (23,597) 546- (24,995)	<u>205,743 -</u> 180,202 202,948 -177,407	<u>77,677 -</u> 52,136 73,483- 47,942	<u>105,485 -</u> 79,944 99,893- 74,352
Planned WSCP Action	up to Stage 2	up to Stage 2	n/a	n/a	n/a
WSCP – Supply Augmentation Benefit	as available	as available	n/a	n/a	n/a
WSCP – Use Reduction Savings Benefit	0 - 20,168	0- 24,995 0- <u>23,597</u>	n/a	n/a	n/a
Revised Surplus/(Shortfall)	0	0	n/a	n/a	n/a
Resulting % Use Reduction from WSCP Action	0% - 11%	0% - 4 <u>13</u> %	n/a	n/a	n/a

As Table 5-7 indicates, the DRA projects supply shortfalls in the planning period. Drought stages from the Water Shortage Contingency Plan (see Chapter 6) are required to address the supply shortfalls. It should be noted both the demand and supply projections include assumptions that

may not actually materialize during the next five years, or may not be as large as projected. For example, customer demands may not increase as projected, or the new FERC license environmental instream flow requirements may not take affect either. Or, supplies may actually be more available than projected from the sample drought. NID will monitor these conditions closely and through the annual assessment process update its supply and demand projections to plan for near-term conditions.

6 Drought Plan

This Drought Plan (Plan) presents Nevada Irrigation District’s (NID, or District) approach for identifying and mitigating various water shortage conditions, pursuant to California Water Code (CWC) §10632. The Plan identifies drought action levels, appropriate agency responses, water demand reduction goals, and provides recommended demand management measures to assist customers in water conservation. For compliance with CWC §10632, the terms Drought Plan and Water Shortage Contingency Plan are considered synonymous.

This Drought Plan is included in the District’s 2020 Urban Water Management Plan (UWMP), although this Drought Plan can be amended, as needed, without the requirement to amend the UWMP. It is noted, the CWC does not exclude the District from taking actions not specifically contained in its Drought Plan in response to supply shortage conditions.

This Plan applies to any shortage condition identified or incurred by the District, including shortages identify by the annual assessment. Further, the Plan shortage levels are also applicable to catastrophic interruption in supplies, including but not limited to, an earthquake, a regional power outage, and other emergency events.

6.1 Legal Authorities

NID is organized under the Irrigation District Law (CWC §§20500-29978) and is authorized to do any act necessary to furnish sufficient water in the district for any beneficial use (CWC §22075), and is therefore granted the authority to enforce its rules and regulations. As a public entity, the District is authorized to “adopt and enforce a water conservation program to reduce the quantity of water used by those persons for the purpose of conserving the water supplies of the public entity” (CWC §375). For the ordinance or resolution regarding the adoption of a conservation plan, the ordinance/resolution is made effective upon adoption (CWC §376).

The aforementioned powers derived from NID’s organizing statutes are in addition to general powers granted to water distributors in CWC §§350-359. CWC §350 authorizes the governing body of a distributor of a public water supply to declare a water shortage emergency whenever it finds and determines that the ordinary demands and requirements of water consumers cannot be satisfied without depleting the water supply of the distributor to the extent there would be insufficient water for human consumption, sanitation, and fire protection. Upon a finding of such an emergency condition, the distributor can adopt such regulations and restrictions on the delivery and consumption of water as will conserve the water supply for the greatest public benefit, with particular regard to domestic use, sanitation, and fire protection (CWC §353). The regulations and

restrictions remain in force and effect until the supply of water available for distribution within such area has been replenished or augmented, and restrictions may include the right to deny new service connections and discontinue service for willful violations (CWC §355 and §356).

The District will vote to adopt its UWMP and Drought Plan as stated in Resolutions/Ordinances XXXX and XXXX, respectfully. The two Resolutions authorize the implementation and enforcement of this Drought Plan, which is included in the 2020 UWMP.

NID will also coordinate with the City of Grass Valley, Nevada City, Auburn, as well as Placer, Nevada, and Yuba counties for the possible proclamation of a “local emergency” under California Government Code, California Emergency Services Act (Article 2, Section 8558).

6.2 Resilience Planning

NID conducts ongoing analysis of its supply reliability and reports on current understanding through its various planning efforts including the Urban Water Management Plan, Plan for Water, Staff Reports to Board, Raw Water Master Plan, and others. Plan for Water is the District’s overarching integrated water resources planning effort. As part of the Plan for Water process, NID has developed a climate change hydrologic model to project and analyze supply availability under different climate change scenarios. Findings from this process will then be used to identify and evaluate mitigation measures. Mitigation measures could include the following:

- Data gathering and information analysis enhancement to further inform decision making
- Hydrologic modeling enhancements
- Demand reduction measures
- Supply augmentation opportunities
- Policy enhancements

The Plan for Water process is ongoing and has not yet begun the mitigation measure evaluation phase. The Plan for Water process is a deliberate, phased approach including customer and stakeholder involvement, and will continue for many months. Once the process develops mitigation strategies and decision support frameworks, NID will update the resiliency planning efforts in the next UWMP. As the Plan for Water process is developing mitigation measures for drought resiliency, NID will continue to implement its current drought and water shortage contingency efforts as described in this Plan.

6.3 Water Supply Reliability Analysis

The District’s snow-melt based water supplies are vulnerable to drought and are expected to be further impacted by climate change. The District holds senior water rights to the majority of its supply and can manage carry over storage quantities based on domestic, municipal, and irrigation needs. However, the supply system relies on spring and summer snowmelt runoff, as well as capture and storage in reservoirs to release during the irrigation season. During droughts and periods of warmer winters when there is less snowpack, runoff is reduced, and the District must manage its storage and customer demands to meet requirements. The supply availability reduction is dependent on the severity and length of the drought. In addition to the hydrologic impacts on NID’s supplies,

there can be regulatory reduction, as during the last drought the State mandated supply curtailments and NID was not able to access its available supply.

As part of NID's UWMP, reliability planning was conducted to evaluate the District's ability to meet demands. Two separate efforts were conducted to characterize both long- and near-term reliability scenarios. The Water Reliability Assessment is conducted for a normal, single dry year, and a drought lasting five consecutive years and is used to evaluate long-term supplies with demands over the next 25 years, in five-year increments. The Drought Risk Assessment assumes the occurrence of a drought over the next five years and aims to assess the District's near-term reliability.

The reliability analysis indicates demand exceeds supplies during single dry year and multiple dry year scenarios, with the single dry year representing approximately 50 percent supply shortfall. This illustrates the highly variable reliability of a snowpack-based supply system during drought periods. There are numerous management and operational efforts available to NID to address supply shortfall during drought periods. Demand reductions, carryover storage strategies, system operational strategies, supplemental supplies, increased storage, and others are all options to evaluate in creating the District's future water resources management supply strategy in the Plan for Water process.

6.4 Annual Water Supply and Demand Assessment

NID conducts an annual analysis of supply and demand projections to help inform water resources management decisions for the coming year. The analysis incorporates various data sources used as evaluation criteria to project probable demands and supply availability for the coming year. Data sources to consider include:

- Projected weather conditions
 - Precipitation versus historical monthly
 - Snow survey results
- Projected Unconstrained Demand
 - Production versus historic monthly
 - New customer growth
 - Water use objective monthly tracking versus goal
 - Identify demand for treated water-supplied water features separate from swimming pools and parks
- Projected Supply Availability (assuming no constraints)
 - Reservoir storage
 - Forecasted runoff
 - PGE contract water
 - Recycled water

The general procedure is listed below. NID may modify this process based on available data, significant events, process restrictions, or other external factors that may impact the process.

1. Dry Year Projection

Compile existing weather data to characterize the past 12 months' conditions. Considering recent conditions and available forecasts, select a projected dry year scenario from the historical precipitation record. Dry year scenario to be at least 60 percent of normal precipitation at the Bowman Lake Reporting Station.

2. Demand Projection

Project unconstrained monthly demand for the next 12 months factoring in existing demands, water use budgets, weather projections, and growth projections.

3. Project Supply Availability

Utilize the existing conditions coupled with historic availability and other known conditions to project probable monthly availability. Summarize the current supply availability over the next 12 months assuming no supply restrictions. Project next year supply availability over the next 12 months assuming the next year is a dry year as selected in Step 1.

4. Supply Infrastructure Restraints

Identify and describe any projected infrastructure restrictions to delivering supply in the next 12 months.

5. Project Next Year Supply Deliverability

Using results from Steps 3 and 4, identify the current conditions normal year and dry year projected supply delivery for the next 12 months.

6. Projected Dry Year Supply to Demand Comparison

Compare the projected next year's unconstrained demand to the next year's dry-year projected supply deliverability. Identify any projected seasonal shortfall in supply to meet the unconstrained demand, cross-referencing the condition to one of the six water shortage levels identified below in this Plan.

7. Develop and propose water resource management strategies to address the projected demand to supply comparison, including reference to one of the water shortage stages identified in this Plan.

8. The annual water supply-demand assessment is presented to the Board of Directors for discussion and questions. Staff will modify/update the assessment per direction from the Board. The Board will approve the assessment and its findings, and can also provide direction to implement specific management strategies at that time. The general proposed timeline is as follows:

- Begin assessment by staff – February
- Present assessment to Board – no later than April
- Submit to State per CWC §10632.1 – by July 1

6.5 Water Shortage Stages and Responses

NID maintains this Drought Plan to identify and respond to potential and actual water shortage conditions. Six water shortage levels are presented per CWC Section 10632(a)(3). Proposed alternative response actions for each stage are identified with each respective projected impact on

demand reduction or supply augmentation listed. NID will evaluate each specific shortage condition and select the appropriate response action(s) for implementation.

The District maintains a water conservation program that is ongoing, even during periods of normal water supply. The District has found this program to be effective in reducing overall water consumption and managing demands during periods of normal water supply and water shortage conditions. The District will rely on its regular conservation program as well as additional measures to respond to the range of water supply shortages that may arise.

6.5.1 Normal Water Supply

Under Normal Water Supply conditions, the District's water supply and distribution system is expected to be able to meet all the water demands of its customers in the immediate future. Regulations for Normal Water Supply are contained in the District's Water Service Rules and Regulations. The following is a list of water usage that the District may consider waste and therefore unreasonable use during all stages, including Normal Water Supply.

Treated Water

- Washing down paved surfaces unless for safety or sanitation, in which case a bucket, a hose with a shut-off nozzle, or a low-volume/high-pressure water broom must be used.
- Watering or irrigating landscapes or vegetation of any kind that creates excessive water flow or runoff onto pavement, gutters, or ditches.
- Washing of vehicle with a hose unless equipped with a water shut-off nozzle (does not apply to commercial car washes).
- Cleaning of gutters by flooding with water.
- Landscape watering during the heat of the day (between 10am and 6pm).
- Use of fountains and water features that do not re-circulate water.
- Failure to repair leaks, breaks, or malfunctions in a timely manner once found or after receiving a notice from the District.
- Outdoor watering during periods of rain.
- Any infraction of mandatory measures in place during the implementation of the District's Drought Plan.

Raw Water

- Failure to repair leaks, breaks, or malfunctions in a timely manner once found, or after receiving notice from the District.
- Water is not confined to the customer's property and being allowed to run off and cause damage to adjoining properties or the roadside ditch or gutter.
- Any infraction of mandatory measures in place during the implementation of this Drought Plan.

Further, the District's Water Service Rules and Regulations prohibit water use outside the District, except when it is deemed surplus to the needs of the District and the Board has declared the water surplus and approved the agreement for sale.

Stage 1 – 10% Supply Shortage
Forecast April 1 Available Supply: 234,999 to 211,500 AF Actions include normal rules and regulations plus those listed below
Treated Water and Municipal Water Customers - Actions to Reduce Demand up to 10 Percent <ul style="list-style-type: none">• Encourage customers to limit outdoor irrigation to every other day.• Request fire department limit practices drills and hydrant flow testing.
Raw Water Customers - Actions to Reduce Demand up to 10 Percent <ul style="list-style-type: none">• Allow Ag customers to voluntarily reduce purchase allotment for the year while reserving their right to return to their previous allotment in the following year if water supply is available.
District Actions <ul style="list-style-type: none">• Communicate conservation regulations as identified in Section 3.05 of District Rules and Regulations.• Declare no new or increased surplus water availability.• Leak repair receives higher priority.• Increase drought awareness through additional public outreach measures that notify the public and customers for declared stage, requirements, and available conservation program support.• Standard rates in effect.
Enforcement Measures <ul style="list-style-type: none">• Standard measures per District Rules and Regulations.

Stage 2 – 20% Supply Shortage

Forecast April 1 Available Supply: 211,499 to 188,000 AF

Actions include Stage 1 plus those listed below

Treated Water and Municipal Water Customers - Actions to Reduce Demand up to 20 Percent

- Outdoor irrigation is limited to every other day and a maximum of three days per week.
- Odd address numbers can irrigate outdoors on Tuesday, Thursday, and Saturday.
- Even address numbers can irrigate outdoors on Wednesday, Friday, and Sunday.
- Customers shall adjust irrigation controllers to reduce usage for each zone by 20 percent.
- Corresponding to Fall Daylight Saving Time, customers shall strive to limit outdoor irrigation to only once per week.

Raw Water Customers - Actions to Reduce Demand up to 20 Percent

- Limit new water sales and increases to 1 miner's inch.
- Required to change delivery schedule developed by the District, aimed at achieving 20 percent demand reduction.

District Actions

- Declare no new or increased surplus water availability.
- Declare no new or increase in Fall/Winter deliveries.
- Communicate mandatory reduction targets to customers.
- Inform Municipal customers of the mandatory 20 percent reduction requirement.
- Distribution system flushing only for public health & safety.
- Organize Drought Hardship Committee.
- Purchase available Contract water to achieve a target carryover of 110,000-acre-feet.
- Implement Stage 2 conservation rates.

Enforcement Measures

- A written warning will be issued for a first violation.
- A District imposed fine of \$250 for a second violation, and any subsequent violation, and doubling with each subsequent violation up to a maximum of \$1,000 for any single violation.
- Upon a fourth violation or an earlier violation, the General Manager determines to create a significant threat to the goals of the stage, the General Manager may order the installation of a flow restrictor on service lines in question.
- Similar penalties, fines, and charges may be implemented by the District as needed to enforce the restrictions on specific prohibited water uses.

Stage 3 – 30% Supply Shortage

Forecast April 1 Available Supply: 187,999 to 164,500 AF
Actions include Stage 2 plus those listed below

Treated Water and Municipal Water Customers - Actions to Reduce Demand up to 30 Percent

- Outdoor irrigation is limited to two days per week.
- Odd address numbers can irrigate outdoors on Thursday and Sunday.
- Even address numbers can irrigate outdoors on Wednesday and Saturday.
- Customers shall adjust irrigation controllers to reduce usage for each zone by 30 percent.
- Irrigation of ornamental turf in public street medians with treated water is prohibited.

Raw Water Customers - Actions to Reduce Demand up to 30 Percent

- Limit new water sale and increases to ½ miner's inch.
- Required to change delivery schedule developed by the District, aimed at achieving 30 percent demand reduction.

District Actions

- Declare no surplus water availability for exterior boundary customers.
- Declare no Fall water availability.
- Communicate mandatory reduction targets to customers.
- Inform Municipal customers of the mandatory 30 percent reduction requirement.
- Purchase available Contract water to achieve a target carryover of 100,000 acre-feet.
- Implement Stage 3 conservation rates.
- Dedicate additional staff for increased water waste patrols.

Enforcement Measures

- A written warning will be issued for a first violation.
- A District imposed fine of \$250 for a second violation, and any subsequent violation, and doubling with each subsequent violation up to a maximum of \$1,000 for any single violation.
- Upon a fourth violation or an earlier violation the General Manager determines to create a significant threat to the goals of the stage, the General Manager may order the installation of a flow restrictor on service lines in question.
- Similar penalties, fines, and charges may be implemented by the District as needed to enforce the restrictions on specific prohibited water uses.

Stage 4 – 40% Supply Shortage

Forecast April 1 Available Supply: 163,499 to 141,000 AF

Actions include Stage 3 plus those listed below

Treated Water and Municipal Water Customers - Actions to Reduce Demand up to 40 Percent

- Outdoor irrigation is limited to one day per week.
- Customers shall adjust irrigation controllers to reduce usage for each zone by 40 percent.

Raw Water Customers - Actions to Reduce Demand up to 40 Percent

- Required to change delivery schedule developed by the District, aimed at achieving 40 percent demand reduction.

District Actions

- Declare no new or increased raw water sales.
- Communicate mandatory reduction targets to customers.
- Inform Municipal customers of the mandatory 40 percent reduction requirement.
- Purchase available Contract water to achieve a target carryover of 90,000 acre-feet.
- Implement Stage 4 conservation rates.

Enforcement Measures

- A written warning will be issued for a first violation.
- A District imposed fine of \$250 for a second violation, and any subsequent violation, and doubling with each subsequent violation up to a maximum of \$1,000 for any single violation.
- Upon a fourth violation, or an earlier violation the General Manager determines to create a significant threat to the goals of the stage, the General Manager may order the installation of a flow restrictor on service lines in question.
- Similar penalties, fines, and charges may be implemented by the District as needed to enforce the restrictions on specific prohibited water uses.

Stage 5 – 50% Supply Shortage

Forecast April 1 Available Supply: 140,999 to 117,500 AF

Actions include Stage 4 plus those listed below

Treated Water and Municipal Water Customers - Actions to Reduce Demand up to 50 Percent

- Outdoor irrigation is prohibited.

Raw Water Customers - Actions to Reduce Demand up to 50 Percent

- Required to change delivery schedule developed by the District, aimed at achieving 50 percent demand reduction.

District Actions

- Communicate mandatory reduction targets to customers.
- Inform Municipal customers of the mandatory 50 percent reduction requirement.
- Purchase available Contract water to achieve a target carryover of 80,000 acre-feet.
- Implement Stage 4 conservation rates.

Enforcement Measures

- A written warning will be issued for a first violation.
- A District imposed fine of \$250 for a second violation, and any subsequent violation, and doubling with each subsequent violation up to a maximum of \$1,000 for any single violation.
- Upon a fourth violation or an earlier violation the General Manager determines to create a significant threat to the goals of the stage, the General Manager may order the installation of a flow restrictor on service lines in question.
- Similar penalties, fines, and charges may be implemented by the District as needed to enforce the restrictions on specific prohibited water uses.

Stage 6 – Over 50% Supply Shortage

Forecast April 1 Available Supply: less than 117,500 AF
Actions include Stage 5 plus those listed below

Treated Water and Municipal Water Customers - Actions to Reduce Demand greater than 50 Percent

- Health and safety use of water only.

Raw Water Customers - Actions to Reduce Demand greater than 50 Percent

- Required to change delivery schedule developed by the District, aimed at achieving target demand reduction.

District Actions

- Communicate the mandatory reduction targets to customers.
- Inform Municipal customers of the mandatory health and safety use only.
- Purchase available Contract water to achieve a target carryover of 75,000 acre-feet.
- Implement Stage 4 conservation rates.
- Other actions as identified specific to the shortage condition.

Enforcement Measures

- A written warning will be issued for a first violation.
- A District imposed fine of \$250 for a second violation, and any subsequent violation, and doubling with each subsequent violation up to a maximum of \$1,000 for any single violation.
- Upon a fourth violation or an earlier violation the General Manager determines to create a significant threat to the goals of the stage, the General Manager may order the installation of a flow restrictor on service lines in question.
- Similar penalties, fines, and charges may be implemented by the District as needed to enforce the restrictions on specific prohibited water uses.

6.6 Enforcement and Variances

NID was formed as an irrigation district under the California Water Code and therefore is granted the authority to enforce its rules and regulations, as well as levy and collect fines. NID will declare a water shortage emergency within its service area boundaries when it determines through its best judgment that normal demands and requirements of its customers cannot be met with the projected supplies.

Once a water shortage stage has been declared, NID will enforce compliance through a multitude of measures commensurate with each reduction goal. The District will either implement measures per this Plan or will provide further discrete requirements through ordinances.

Measures will be enforced through the following procedures, in addition to any enforcement measures identified in ordinances. NID will modify and adjust the compliance strategy as necessary for each respective situation.

- A written warning will be issued for a first violation.
- A District imposed fine of \$250 for a second violation, and any subsequent violation, and doubling with each subsequent violation up to a maximum of \$1,000 for any single violation.
- Upon a fourth violation or an earlier violation the General Manager determines to create a significant threat to the goals of the ordinance, the General Manager may order the installation of a flow restrictor on service lines in question.
- Similar penalties, fines, and charges may be implemented by the District as needed to enforce the restrictions on specific prohibited water uses.

Upon declaration of a Stage 2 shortage (or higher), NID will appoint and convene the Drought Hardship Committee. The Drought Hardship Committee is an advisory body and shall consist of one appointee from each director's division and the Water and Hydroelectric Operations (WHO) Board Committee. District Operation's staff will work closely with the committee.

The Drought Hardship Committee's purpose is to review the applications and determine whether additional water can be provided to the applicant. Before any appeal for a variance can be heard by the Drought Hardship Committee, raw water customers must submit a Drought Hardship Application and provide proof the water is being used for commercial agricultural purposes.

For the purposes of this Plan, the definition of commercial agriculture is an agricultural producer engaged in a for-profit operation with a minimum gross annual sales of \$3,000 and a minimum capital investment of \$15,000. Commercial agricultural producers file a Schedule F with the Internal Revenue Service for their farming or ranching operation.

Variances may be approved for increases in raw water deliveries, seasonal variances, relief from regulations regarding treated water customers, or other protocols as determined by the Drought Hardship Committee. No such variance or appeal, however, shall be granted if the Board of Directors finds that the variance or appeal will adversely affect the public health or safety of others and is not in the public's best interest.

Under the California Water Code, in critical water supply situations, there is a priority that shall be allocated as follows:

1. Human Consumption
2. Livestock and Animals
3. Perennial Crops
4. Annual Crops

Upon granting a Drought Hardship Variance or appeal, the Board may impose any other conditions it deems to be just and proper.

6.7 Communication Protocols

NID maintains an established and effective communications program to inform its customers, neighbors, and other stakeholders of issues, updates, and policies. Implementation of the Drought Plan will utilize the existing communication program structure to inform customers and others of the declared shortage stage and respective actions and restrictions in place.

The Board meetings addressing the Annual Water Supply and Demand Assessment and/or a potential water-shortage declaration will be noticed per normal Board meeting public notification procedures. The meeting will also be announced through regular press release protocols.

Once a shortage stage has been declared by the Board of Directors, NID will notify its customers and others through a range of efforts. The stage and restrictions will be identified in a press release, as well as customer billing statements. The District's website will be updated to feature the shortage declaration, restrictions, and resources available to customers from the District and other entities to help meet the restrictions. Subsequent Board of Directors meetings will include a review of the shortage condition, customer response results, and discussion and recommendations for potential modifications.

6.8 Financial Consequences of Drought Plan

Implementing any stage of the Drought Plan is expected to impact the District's financial status, including enforcement of excessive residential water use during a drought (compliance with Chapter 3.3, Division 1 of the CWC). As experienced during previous droughts, it is expected that revenues will decrease with decreasing usage, and expenses will increase with additional monitoring and enforcement responsibilities, as well as additional costs for replacement supplies if needed.

The District maintains a rate structure that includes a fixed meter charge plus increasing volumetric block rates for residential customers and volumetric rates for irrigation customers. Volumetric revenue is approximately 53 percent of total revenue. The drought rate structure is set to offset the revenue loss from mandatory demand reduction up to 40 percent. Demand reduction above 40 percent will reduce revenue accordingly. Actual impacts will vary depending on customer response.

Enforcement, enhanced outreach, and increase of customer data tracking can add to the District's costs around a water shortage condition. Oftentimes, these additional efforts are prioritized for current staff, and other normal work efforts are delayed or reassigned. If conditions warrant, the District will seek assistance through additional staffing or third-party service providers. These costs

depend on the level of support and will be evaluated on a case-by-case basis. An increase in costs can also be associated with additional equipment obtained to support the District's outreach, enforcement, tracking, and management efforts.

Depending on the situation, the District may also be able to obtain supplemental water supplies to mitigate the water shortage condition. These supplies are expected to be more costly than regular supplies and will be evaluated for each specific opportunity.

It is reasonable to expect financial impacts or changes in cash flow during a prolonged water shortage condition. The District will enact a range of management and financial resources depending on the specific situation that includes:

- Drought rate surcharge
- Utilizing financial reserves
- Capital project deferment
- Operational and maintenance expense deferment
- Increased revenue from penalties
- And others as identified

6.9 Monitoring, Reporting, and Refinement

The Drought Plan aims to ensure demands are reduced and/or supply is augmented to balance supply and demand. The District will enact various actions commensurate with each respective stage. The District will then monitor results to maintain the supply/demand balance. Similar to the supply and demand projections used to establish a shortage condition in the annual assessment procedure, the District will monitor the same data to determine effectiveness and efficacy. District staff will report to the Board of Directors at least monthly on status and results. Data reporting will include:

- Actual demands to projected demands per customer class and on total
- Actual supply availability and utilized to projected availability per each supply source
- Projected supply availability for next 12 months per supply source
- Any specific requirements identified by the State in the future

Data will also be submitted to the State per any future reporting requirements.

Progress and efficacy will be summarized from the results data. The District will evaluate the need for any changes or modifications to the declared water shortage stage or actions based on the results. The District may determine to enact additional measures, develop ordinances, or update the Drought Plan as a whole. Any Plan update or modification will be conducted through the Board of Directors meeting process unless specific conditions require otherwise.

6.10 Response Action Estimates

The following table presents the individual estimated demand savings of each response action. Actual savings will likely vary greatly based on external influences, shortage stage level, and general

customer understanding of drought severity. It is assumed the savings estimates are not necessarily additive, but when implemented together as a program with all the actions in each respective stage, they are intended and estimated to eliminate each stage’s identified supply to demand shortage gap.

Table 6-1. Shortage Response Action Measures Estimates

Stage	Shortage Response Action	Potential Shortage Gap Reduction
1	Treated Customers - Encouraged to limit outdoor irrigation to every other day.	0 - 3%
1+	Treated Customers - Fire departments limit practice drills and hydrant flow testing.	0 - 1%
1	Raw Water Customers - Asked to voluntarily reduce purchase allotment for the year while reserving their right to return to their previous allotment in the following year if water supply is available.	0 - 10%
1+	District - Communicate conservation regulations as identified in Section 3.05 of District’s Rules and Regulations.	0 - 1%
1+	District - Declare no new or increased surplus water availability.	0 - 2%
1+	District - Leak repair receives higher priority.	0 - 2%
1+	District - Increase drought awareness through additional public outreach measures that notify public and customers of declared stage, requirements, and available conservation program support.	0 - 3%
2	Treated Customers - Outdoor irrigation is limited to every other day and a maximum of three days per week.	1 - 3%
2	Treated Customers - Corresponding to Fall Daylight Savings Time, customers shall strive to limit outdoor irrigation to only once per week.	1 - 2%
2	Raw Water Customers - New water sales and increases limited to one miner’s inch.	2 - 5%
2	Raw Water Customers - Required to change delivery schedule developed by the District aimed at achieving a 20 percent demand reduction.	10 - 20%
2	District - Declare no new or increase in Fall/Winter deliveries.	0 - 2%
2	District - Communicate mandatory reduction targets to customers.	4 - 8%
2	District - Inform Municipal customers of the mandatory 20 percent reduction requirement.	1 - 2%
2+	District - Distribution system flushing only for public health and safety.	1 - 2%

Stage	Shortage Response Action	Potential Shortage Gap Reduction
2	District - Purchase available Contract water to achieve a target carryover of 110,000 acre-feet.	5 - 20%
2	District - Implement Stage 2 conservation rates.	3 - 5%
2+	District - Enhanced enforcement measures.	1 - 3%
3	Treated Customers - Outdoor irrigation is limited to two days per week.	2 - 3%
3	Treated Customers - Adjust irrigation controllers to reduce usage for each zone by 30 percent.	2 - 3%
3+	Treated Customers - Irrigation of ornamental turf in public street medians with treated water is prohibited.	1 - 2%
3	Raw Water Customers - New water sales and increases limited to 1/2 miner's inch.	3 - 6%
3	Raw Water Customers - Required to change delivery schedule developed by the District aimed at achieving a 30 percent demand reduction.	15 - 30%
3	District - Declare no surplus water availability for exterior boundary customers.	1 - 2%
3+	District - Declare no Fall water availability.	5 - 10%
3	District - Inform Municipal customers of the mandatory 30 percent reduction requirement.	2 - 3%
3	District - Purchase available Contract water to achieve a target carryover of 100,000 acre-feet.	5 - 20%
3	District - Implement Stage 3 conservation rates.	5 - 7%
3	District - Dedicate additional staff for increased water waste patrols.	0 - 3%
4	Treated Customers - Outdoor irrigation is limited to one day per week.	3 - 6%
4	Treated Customers - Adjust irrigation controllers to reduce usage for each zone by 40 percent.	3 - 6%
4	Raw Water Customers - Required to change delivery schedule developed by the District aimed at achieving a 40 percent demand reduction.	25 - 40%
4	District - Declare no new or increased raw water sales.	1 - 5%
4	District - Inform Municipal customers of the mandatory 40 percent reduction requirement.	3 - 4%
4	District - Purchase available Contract water to achieve a target carryover of 90,000 acre-feet.	5 - 20%

Stage	Shortage Response Action	Potential Shortage Gap Reduction
4+	District - Implement Stage 4 conservation rates.	6 - 8%
5	Treated Customers - Outdoor irrigation is prohibited.	10 - 25%
5	Raw Water Customers - Required to change delivery schedule developed by the District aimed at achieving a 50 percent demand reduction.	20 - 30%
5	District - Inform Municipal customers of the mandatory 50 percent reduction requirement.	4 - 6%
5	District - Purchase available Contract water to achieve a target carryover of 80,000 acre-feet.	5 - 20%
6	Treated Customers - Health and safety use of water only.	6 - 10%
6	Raw Water Customers - Required to change delivery schedule developed by the District aimed at achieving target demand reduction.	varies
6	District - Inform Municipal customers of the mandatory health and safety use only.	6 - 9%
6	District - Purchase available Contract water to achieve a target carryover of 75,000 acre-feet.	5 - 20%
6	District - Other actions as identified specific to the shortage condition.	varies

6.11 Plan Adoption, Submittal, and Availability

The Drought Plan (including subsequent updates) shall be adopted in accordance with standard District procedures, including requirements for public participation (public hearing), and approval by the NID Board of Directors. Upon adoption, the Drought Plan will be provided to the City of Grass Valley, Nevada City, Placer, Nevada, and Yuba counties, and submitted to DWR within 30 days. The adopted Drought Plan will be available on the District’s website, as well as at the District office.

6.12 Seismic Risk Assessment and Mitigation

Nevada and Placer counties have completed Local Hazard Mitigation Plans under the federal Disaster Mitigation Act of 2000 (Public Law 106-390). Per DWR requirements, a copy of the most recent adopted plan by each County will be submitted as part of the UWMP submittal to DWR.

7 Demand Management Measures

The District is dedicated to responsible stewardship of water supplies and conducts an active and ongoing water conservation program aimed thereto. Water conservation is achieved through managing the water supply and water demand for all customer sectors. Through reduction in loss and waste within the District's production and delivery systems, supply management is used to improve the overall system efficiency. NID relies on demand management and conservation programs to educate and encourage water conservation. Demand management measures (DMMs) are intended to facilitate NID's management and reduction of customer demands, and aid in maintaining supply reliability. The District has utilized these DMMs to meet customer use targets, including SBX7-7 and drought conservation targets. NID anticipates that DMMs will serve as tools to rely on when meeting compliance with future water use targets, including Water Use Objectives. All of the DMMs presented below have been implemented over the previous five years.

7.1 Water Waste Prevention Ordinances

Water waste prohibition is an ongoing component of the District's water conservation program. The District has adopted regulations which state that "a water user who wastes water, either willfully, carelessly, or due to defective or inadequate private facilities, may be subject to fines, reduction, or termination of service" (Water Service Regulations, Section 3.05 Water Conservation).

NID has an established and active water waste reporting program. Customers can report water waste through the District's website or by telephone. The primary tool to address reported customer waste is outreach and education. Contact is made with the customer as a follow up to the water waste report. They are informed of the report and advised of ways to correct as necessary. Per the District's water service rules and regulations, continued violations may lead to a fine, reduction in service, or termination of service. The District's Water Efficiency Technician monitors leak alerts and contacts customers alerting them of the unusually high use. In addition, the District is currently conducting a pilot program for customers equipped with a Badger meter. The pilot program includes water use software that monitors flows and sends alerts to customers with unusual increases in usage patterns. This notification has historically been sufficient to prompt immediate corrective actions for most NID customers.

NID anticipates continually implementing this DMM, as it provides a proactive approach for addressing water waste by District customers.

7.2 Metering

The District is fully metered and all treated water connections are billed based on the volume of water used. The metered connections allow the District to better monitor customer use during drought conditions when tracking is required. NID is actively replacing automatic meter reading (AMR) meters with automatic metering infrastructure (AMI) meters. Existing AMR meters are replaced when components fail, and currently 9,800 meters have been replaced. The AMI meters will allow real time water use comparisons and leak reporting. It is anticipated that District customers will have access to their usage through NID's website. NID projects that the meter replacement program will be completed in the next five years.

This DMM is fully implemented and the District will continue to install and read meters on all new services. Additionally, the District has begun the replacement of its meters to cellular read. The District's AMR/AMI program allows the District to automatically identify customer with high usage rates for potential leak issues. It is anticipated that the District will continue to implement large meter replacement (upgrading to AMI) during 2021.

7.3 Conservation Pricing

The District began implementing an inclining block rate structure for all urban water customer sectors in 1996. All customer sectors and meter sizes receive a monthly Tier 1 allocation of five hundred cubic feet. Usage above the Tier 1 allocation is billed at a higher block rate. The District's inclining rate structure is applicable to the District's Commercial and Non-commercial customers.

The implementation of this DMM is ongoing as it promotes efficient use of the resource. The District plans to continue implementing its inclining block rate to facilitate the District's goal of conservation. Effectiveness of this DMM is evaluated by comparison of the District water use before and following the implementation of conservation pricing. The District can monitor the number of violators who use water more than their established allotment.

7.4 Public Education and Outreach

Public information is an ongoing component of the District's water conservation program. The Water Efficiency Technician leads the effort to promote water conservation and awareness through a variety of methods. NID prepares and distributes public information through bill inserts, newsletters, brochures, community speakers, advertising, web page, library, and many special events throughout the year. Periodically, the District prepares news releases and public announcements through local media, including local radio stations, relating to water conservation issues.

The District also publishes and distributes a newsletter four times a year. The newsletter contains articles and information on water conservation. Previously, the District published a booklet entitled "Water Conservation Gardening" to assist its customers in implementing applicable conservation measures. The "Lawn Watering Guide" was published by the District in 1989 and is updated or reprinted as needed. The District also partners with the UC Cooperative Extension Master Gardeners which produce "Water Wise Landscaping" periodicals annually. The District offers this information to customers and makes it publicly available on the District's water efficiency webpage.

Detailed information on the District's public outreach programs are presented below. In addition to event flyers, District presentations, and media release, Appendix D contains samples of public information distributed by the District.

Mulch Magic Giveaway: This program entails partnering with Nevada County Resource Conservation District (NCRDC) to educate the community of the multiple benefits of mulch, including water savings. To date, over 650 cubic yards of shredded cedar has been given away to Nevada and Placer County residents.

Irrigation Efficiency Workshops: Another program that involves partnership with NCRCD is the Irrigation Efficiency Workshops. The workshops focus on irrigated pasture management and crop

efficiency. Two or more workshops were completed each year from 2011-2019 with an average of 40 participants per workshop.

NID Landscaping Project: NID's Water Wise Irrigation Project consisted of removing a portion of turf at the District's headquarters office and replacing with planting and irrigation systems for a demonstration on how to provide water efficient landscaping. Since the project was completed, NID performs regular maintenance to the garden, and anticipates conducting irrigation tours in the future.

Water Conservation School Assemblies: NID worked with South Yuba River Citizens League to provide multiple water conservation school assemblies known as "The Great Water Mystery". The assembly was offered at schools located within the District's service area and was completed in 2016.

Nevada County Building Fair: NID's Water Efficiency Technician and Business Services Technician attend the Nevada County Building Fair. There, they coordinate a booth with information and giveaways for attendees aimed at increasing efficiency awareness.

Farm Days: Farms Days is targeted to educate approximately 500 2nd and 3rd graders in Nevada County about the importance of Agriculture, including the importance of responsible water use practices. NID's booth consisted of interactive educational materials and activities for the children. As this event is aimed at public education and outreach, the District anticipates participating in this annual event for the foreseeable future.

Lincoln Creek Fest: NID offered a booth at the Lincoln Creek Fest, bringing awareness to members of the Lincoln Community of NID's role in the area. Coasters, seed packets, magnets, toilet tabs, and informational pamphlets were given away to attendees. The Lincoln Creek Fest is aimed at educating the public about local creeks and waterways and included a "Creek Clean-Up" activity for participants.

Sustainable Food and Farm Conference: NID has hosted educational booths at this conference for the past three years. Educational information on water efficient plants, NID's service area, and raw water were provided.

Table Tents: NID distributes "Water Served Upon Request" table tents to restaurants within the District's service area. This program is aimed at promoting public awareness of water conservation, and offers individuals a way to actively contribute toward the overall goal of conservation.

Poster/Slogan Contests: NID works with schools within the service area to promote a poster/slogan contest. Possible incentives include a gift card drawing for teachers who have students participating with 1st, 2nd and 3rd place winners for each age group. Winners are honored at District Board meetings and posters are displayed in the District office and/or local businesses. Due to the COVID pandemic, this program was delayed during 2020, although the District expects to employ the program when the opportunity arises. The District anticipates ongoing implementation of this program.

Implementation of the District's public outreach and education program is active and ongoing, although some activities have been limited due to the COVID pandemic. The District plans to continue to develop information and activities aimed at conservation messaging and awareness to

the public. The water savings from these programs are not directly quantified, and are considered passive.

7.5 Programs to Assess and Manage Distribution System Real Loss

Ongoing leak detection and repair within the system, focused on the high probability leak areas, is used to assess and manage the system's real losses. This includes a continuing meter calibration and replacement program for all production and distribution meters. The District conducts annual water audits and leak detection and repair on an ongoing basis. The District conducted a water loss audits during 2016 through 2020 as described in Chapter 3. Because the District maintains records on all leaks repaired on its treated water system, the information is annually reviewed and used to determine which pipelines should be considered for replacement as part of the annual budgeted project list. The ongoing budget for repair and replacement of leaking treated water distribution pipes amounts to approximately \$1 million annually.

The program for leak detection and repair began in 1985. The District will continue to audit their water distribution systems, per American Water Works Association (AWWA) guidelines, by comparing water produced and water delivered. Each system is audited at least annually. The District will continue its leak detection program and will schedule surveys on high water loss systems as determined by the annual water audits and leak history records. The District will continue rehabilitating its water distribution system by replacing water mains with extensive leak histories. Water Efficiency staff continue to work with various departments to improve and refine data collection aimed at improving the District's validity score where appropriate.

Effectiveness of NID's programs to assess and manage the Distribution system real loss is evaluated by tracking leak detection and leak repair and comparison of prior water use to future water use. The District maintains records of numbers and locations of leaks that are detected and repaired each year. The District implemented an asset management program beginning in 2015 to be able to better track repairs.

7.6 Water Conservation Program Coordination and Staffing Support

Since 2011 the District has staffed a full-time water conservation coordinator water efficiency technician. The conservation coordinator performs a variety of highly responsible technical duties in support of the District's water conservation program, including water distribution and production activities. The conservation coordinator plans, organizes, tracks, implements and reports on various water efficiency, distribution and production programs, conducts public outreach/education activities regarding the District's water efficiency, and investigates reports of water waste. The conservation coordinator identifies, recommends, and implements programs and activities that will improve water use efficiency by NID customers. The conservation coordinator develops programs to efficiently communicate to NID customer base, and has established a toilet rebate program, a retrofit program at the local fair grounds, and mulch giveaway events.

The implementation of the District's water conservation program is ongoing. Recent budget allotments have averaged \$271,000 per year, which includes programmatic and staff costs. Water savings from this DMM cannot be directly quantified. Effectiveness of this DMM is evaluated by the overall success of the District's water conservation program.

7.7 Other Demand Management Measures

In addition to the DMMs presented above, NID also undertakes various programs and provides rebates aimed at increasing water use efficiency and reducing waste. Information on these additional DMMs employed by the District is presented below.

Leak Detection: Starting with the new cellular read (Badger) meters, leak detection was a new project beginning in 2017. The Badger meters are actively monitored and NID is notified of water usage at a property for more than 24 hours. The Water Efficiency Technician monitors the leaks and makes contact with the customer regarding the apparent leak.

High Efficiency Toilet Rebate Program: NID's Toilet Rebate Program was developed to provide a financial incentive to encourage customers to replace older, inefficient toilets with High Efficiency Toilets (HET). The HETs are rated at 1.28 gallons per flush or less, and implementation of this program is estimated to conserve up to 3.4 million gallons of water annually. To date, NID has sent out 71 rebate applications, and approved 27 toilet rebates. Since implementation of this program, no rebate application has been denied.

Large Landscape Conservation Program Incentives: NID promotes informed landscape water management to encourage conservation through a Demonstration Garden located at the Grass Valley office. At the Demonstration Garden, NID has prepared and makes available irrigation educational information for all customers. As presented earlier, the District's newsletter is published four times a year and informs the public of the District's Demonstration Garden. The large landscape conservation program consists of actions for dedicated irrigation accounts as well as mixed metered or non-metered CII accounts to implement. NID advertises and hosts irrigation seminars annually to reduce water usage, improve irrigation scheduling, and create more efficient irrigation systems. The educational seminars are applicable to large landscape customers, including raw water and treated customers. Appendix D contains information on the irrigation seminars provided by the District.

CII Accounts Surveys: All of the District's 838 CII accounts are metered. The District has sorted these accounts to market and target those with the largest meters and highest consumption. As needed, the District will be working with those customers to reduce usage and identify inefficiencies.

Agricultural Water Conservation: In 2015 and 2020, the District prepared an Agricultural Water Management Plan in compliance with the Agricultural Water Management Planning Act. The Agricultural Water Management Planning Act calls for agricultural water suppliers to report on which efficient water management practices they have implemented and plan to implement and to describe the associated water use efficiency improvements. The District continues to implement water measurement and volume based pricing with an incentive pricing structure for all agricultural customers. Gaging stations to help monitor flows at intermediate locations along the canals as well as automating reading stations will continued to be installed annually. The District holds water efficiency workshops annually (on hold during the pandemic). The District actively inspects and maintains raw water supply pumps, conducts pump efficiency tests, and replaces pumps as necessary and as funding allows. The District continues to work with PG&E to increase the flexibility in the timing and location of the PG&E supply so that the District can more efficiently manage the water

supply. The District's agricultural efficient water management practices are described in detail in the recently adopted 2020 Agricultural Water Management Plan.



Nevada Irrigation District

2020 Urban Water Management Plan

**Public Draft
Appendices**

June- 2021

Appendix A: 2020 UWMP Checklist

Retail	Wholesale	2020 Guidebook Location	Water Code Section	Summary as Applies to UWMP	Subject	2020 UWMP Location (Optional Column for Agency Review Use)
x	x	Chapter 1	10615	A plan shall describe and evaluate sources of supply, reasonable and practical efficient uses, reclamation and demand management activities.	Introduction and Overview	Chapter 3 Chapter 4 Chapter 7
x	x	Chapter 1	10630.5	Each plan shall include a simple description of the supplier's plan including water availability, future requirements, a strategy for meeting needs, and other pertinent information. Additionally, a supplier may also choose to include a simple description at the beginning of each chapter.	Summary	Section 1.1
x	x	Section 2.2	10620(b)	Every person that becomes an urban water supplier shall adopt an urban water management plan within one year after it has become an urban water supplier.	Plan Preparation	Section 1.2
x	x	Section 2.6	10620(d)(2)	Coordinate the preparation of its plan with other appropriate agencies in the area, including other water suppliers that share a common source, water management agencies, and relevant public agencies, to the extent practicable.	Plan Preparation	Section 1.3 Section 1.4 Section 1.5 Table 1-2
x	x	Section 2.6.2	10642	Provide supporting documentation that the water supplier has encouraged active involvement of diverse social, cultural, and economic elements of the population within the service area prior to and during the preparation of the plan and contingency plan.	Plan Preparation	Section 1.5 Appendix B
x		Section 2.6, Section 6.1	10631(h)	Retail suppliers will include documentation that they have provided their wholesale supplier(s) - if any - with water use projections from that source.	System Supplies	n/a
	x	Section 2.6	10631(h)	Wholesale suppliers will include documentation that they have provided their urban water suppliers with identification and quantification of the existing and planned sources of water available from the wholesale to the urban supplier during various water year types.	System Supplies	n/a
x	x	Section 3.1	10631(a)	Describe the water supplier service area.	System Description	Section 2.1
x	x	Section 3.3	10631(a)	Describe the climate of the service area of the supplier.	System Description	Section 2.2
x	x	Section 3.4	10631(a)	Provide population projections for 2025, 2030, 2035, 2040 and optionally 2045.	System Description	Section 2.6 Table 2-5
x	x	Section 3.4.2	10631(a)	Describe other social, economic, and demographic factors affecting the supplier's water management planning.	System Description	Section 2.4
x	x	Sections 3.4 and 5.4	10631(a)	Indicate the current population of the service area.	System Description and Baselines and Targets	Table 2-5
x	x	Section 3.5	10631(a)	Describe the land uses within the service area.	System Description	Section 2.3 Table 2-3
x	x	Section 4.2	10631(d)(1)	Quantify past, current, and projected water use, identifying the uses among water use sectors.	System Water Use	Section 3.1.1 Table 3-1 Section 3.1.2 Table 3-2 Section 3.1.3 Table 3-3 Section 3.1.4 Table 3-4 Table 3-5 Section 3.2 Table 3-7 Section 3.3 Table 3-9 Section 3.4 Table 3-10
x	x	Section 4.2.4	10631(d)(3)(C)	Retail suppliers shall provide data to show the distribution loss standards were met.	System Water Use	Section 3.2 Table 3-7
x	x	Section 4.2.6	10631(d)(4)(A)	In projected water use, include estimates of water savings from adopted codes, plans, and other policies or laws.	System Water Use	Section 3.4 Table 3-10 Table 3-11

Retail	Wholesale	2020 Guidebook Location	Water Code Section	Summary as Applies to UWMP	Subject	2020 UWMP Location (Optional Column for Agency Review Use)
x	x	Section 4.2.6	10631(d)(4)(B)	Provide citations of codes, standards, ordinances, or plans used to make water use projections.	System Water Use	Section 3.4
x	optional	Section 4.3.2.4	10631(d)(3)(A)	Report the distribution system water loss for each of the 5 years preceding the plan update.	System Water Use	Table 3-7
x	optional	Section 4.4	10631.1(a)	Include projected water use needed for lower income housing projected in the service area of the supplier.	System Water Use	Table 3-10 Section 3.6
x	x	Section 4.5	10635(b)	Demands under climate change considerations must be included as part of the drought risk assessment.	System Water Use	Section 3.5 Table 3-13 Section 5.2 Table 5-7
x		Chapter 5	10608.20(e)	Retail suppliers shall provide baseline daily per capita water use, urban water use target, and compliance daily per capita water use, along with the bases for determining those estimates, including references to supporting data.	Baselines and Targets	Section 3.7 Table 3-14
x		Chapter 5	10608.24(a)	Retail suppliers shall meet their water use target by December 31, 2020.	Baselines and Targets	Section 3.7 Table 3-14
	x	Section 5.1	10608.36	Wholesale suppliers shall include an assessment of present and proposed future measures, programs, and policies to help their retail water suppliers achieve targeted water use reductions.	Baselines and Targets	n/a
x		Section 5.2	10608.24(d)(2)	If the retail supplier adjusts its compliance GPCD using weather normalization, economic adjustment, or extraordinary events, it shall provide the basis for, and data supporting the adjustment.	Baselines and Targets	n/a
x		Section 5.5	10608.22	Retail suppliers' per capita daily water use reduction shall be no less than 5 percent of base daily per capita water use of the 5-year baseline. This does not apply if the suppliers base GPCD is at or below 100.	Baselines and Targets	Section 3.7
x		Section 5.5 and Appendix E	10608.4	Retail suppliers shall report on their compliance in meeting their water use targets. The data shall be reported using a standardized form in the SBX7-7 2020 Compliance Form.	Baselines and Targets	Section 3.7 Table 3-14
x	x	Sections 6.1 and 6.2	10631(b)(1)	Provide a discussion of anticipated supply availability under a normal, single dry year, and a drought lasting five years, as well as more frequent and severe periods of drought.	System Supplies	Section 5.1.2
x	x	Sections 6.1	10631(b)(1)	Provide a discussion of anticipated supply availability under a normal, single dry year, and a drought lasting five years, as well as more frequent and severe periods of drought, <i>including changes in supply due to climate change.</i>	System Supplies	Section 5.1.2
x	x	Section 6.1	10631(b)(2)	When multiple sources of water supply are identified, describe the management of each supply in relationship to other identified supplies.	System Supplies	Section 4.8 Section 4.9.1
x	x	Section 6.1.1	10631(b)(3)	Describe measures taken to acquire and develop planned sources of water.	System Supplies	Section 4.7 Table 4-5
x	x	Section 6.2.8	10631(b)	Identify and quantify the existing and planned sources of water available for 2020, 2025, 2030, 2035, 2040 and optionally 2045.	System Supplies	Section 4.8 Table 4-6 Table 4-7
x	x	Section 6.2	10631(b)	Indicate whether groundwater is an existing or planned source of water available to the supplier.	System Supplies	Section 4.2
x	x	Section 6.2.2	10631(b)(4)(A)	Indicate whether a groundwater sustainability plan or groundwater management plan has been adopted by the water supplier or if there is any other specific authorization for groundwater management. Include a copy of the plan or authorization.	System Supplies	n/a
x	x	Section 6.2.2	10631(b)(4)(B)	Describe the groundwater basin.	System Supplies	n/a

Retail	Wholesale	2020 Guidebook Location	Water Code Section	Summary as Applies to UWMP	Subject	2020 UWMP Location (Optional Column for Agency Review Use)
x	x	Section 6.2.2	10631(b)(4)(B)	Indicate if the basin has been adjudicated and include a copy of the court order or decree and a description of the amount of water the supplier has the legal right to pump.	System Supplies	n/a
x	x	Section 6.2.2.1	10631(b)(4)(B)	For unadjudicated basins, indicate whether or not the department has identified the basin as a high or medium priority. Describe efforts by the supplier to coordinate with sustainability or groundwater agencies to achieve sustainable groundwater conditions.	System Supplies	n/a
x	x	Section 6.2.2.4	10631(b)(4)(C)	Provide a detailed description and analysis of the location, amount, and sufficiency of groundwater pumped by the urban water supplier for the past five year.	System Supplies	n/a
x	x	Section 6.2.2	10631(b)(4)(D)	Provide a detailed description and analysis of the amount and location of groundwater that is projected to be pumped.	System Supplies	n/a
x	x	Section 6.2.7	10631(c)	Describe the opportunities for exchanges or transfers of water on a short-term or long-term basis.	System Supplies	Section 4.6
x	x	Section 6.2.5	10633(b)	Describe the quantity of treated wastewater that meets recycled water standards, is being discharged, and is otherwise available for use in a recycled water project.	System Supplies (Recycled Water)	Section 4.4 Section 4.4.1 Table 4-1 Table 4-2
x	x	Section 6.2.5	10633(c)	Describe the recycled water currently being used in the supplier's service area.	System Supplies (Recycled Water)	Section 4.4.1 Table 4-2 Section 4.4.2
x	x	Section 6.2.5	10633(d)	Describe and quantify the potential uses of recycled water and provide a determination of the technical and economic feasibility of those uses.	System Supplies (Recycled Water)	Section 4.4.3 Table 4-3
x	x	Section 6.2.5	10633(e)	Describe the projected use of recycled water within the supplier's service area at the end of 5, 10, 15, and 20 years, and a description of the actual use of recycled water in comparison to uses previously projected.	System Supplies (Recycled Water)	Section 4.4.3 Table 4-4
x	x	Section 6.2.5	10633(f)	Describe the actions which may be taken to encourage the use of recycled water and the projected results of these actions in terms of acre-feet of recycled water used per year.	System Supplies (Recycled Water)	Section 4.4.4 Table 4-3
x	x	Section 6.2.5	10633(g)	Provide a plan for optimizing the use of recycled water in the supplier's service area.	System Supplies (Recycled Water)	Section 4.4.4
x	x	Section 6.2.6	10631(g)	Describe desalinated water project opportunities for long-term supply.	System Supplies	Section 4-5
x	x	Section 6.2.5	10633(a)	Describe the wastewater collection and treatment systems in the supplier's service area with quantified amount of collection and treatment and the disposal methods.	System Supplies (Recycled Water)	Section 4.4.1 Table 4-1 Table 4-2
x	x	Section 6.2.8, Section 6.3.7	10631(f)	Describe the expected future water supply projects and programs that may be undertaken by the water supplier to address water supply reliability in average, single-dry, and for a period of drought lasting 5 consecutive water years.	System Supplies	Section 4-7 Table 4-5
x	x	Section 6.4 and Appendix O	10631.2(a)	The UWMP must include energy information, as stated in the code, that a supplier can readily obtain.	System Supplies, Energy Intensity	Section 4.10 Table 4-11
x	x	Section 7.2	10634	Provide information on the quality of existing sources of water available to the supplier and the manner in which water quality affects water management strategies and supply reliability	Water Supply Reliability Assessment	Section 5.1.1
x	x	Section 7.2.4	10620(f)	Describe water management tools and options to maximize resources and minimize the need to import water from other regions.	Water Supply Reliability Assessment	Chapter 7 (and subsections)

Retail	Wholesale	2020 Guidebook Location	Water Code Section	Summary as Applies to UWMP	Subject	2020 UWMP Location (Optional Column for Agency Review Use)
x	x	Section 7.3	10635(a)	Service Reliability Assessment: Assess the water supply reliability during normal, dry, and a drought lasting five consecutive water years by comparing the total water supply sources available to the water supplier with the total projected water use over the next 20 years.	Water Supply Reliability Assessment	Section 5.1.2 Table 5-4 Table 5-5 Table 5-6
x	x	Section 7.3	10635(b)	Provide a drought risk assessment as part of information considered in developing the demand management measures and water supply projects.	Water Supply Reliability Assessment	Section 5.2 Table 5-7
x	x	Section 7.3	10635(b)(1)	Include a description of the data, methodology, and basis for one or more supply shortage conditions that are necessary to conduct a drought risk assessment for a drought period that lasts 5 consecutive years.	Water Supply Reliability Assessment	Section 6.4
x	x	Section 7.3	10635(b)(2)	Include a determination of the reliability of each source of supply under a variety of water shortage conditions.	Water Supply Reliability Assessment	Section 5.1.2 Table 5-1 Table 5-2 Table 5-3
x	x	Section 7.3	10635(b)(3)	Include a comparison of the total water supply sources available to the water supplier with the total projected water use for the drought period.	Water Supply Reliability Assessment	Table 5-7
x	x	Section 7.3	10635(b)(4)	Include considerations of the historical drought hydrology, plausible changes on projected supplies and demands under climate change conditions, anticipated regulatory changes, and other locally applicable criteria.	Water Supply Reliability Assessment	Section 5.2
x	x	Chapter 8	10632(a)	Provide a water shortage contingency plan (WSCP) with specified elements below.	Water Shortage Contingency Planning	Chapter 6
x	x	Chapter 8	10632(a)(1)	Provide the analysis of water supply reliability (from Chapter 7 of Guidebook) in the WSCP	Water Shortage Contingency Planning	Section 6.3
x	x	Section 8.10	10632(a)(10)	Describe reevaluation and improvement procedures for monitoring and evaluation the water shortage contingency plan to ensure risk tolerance is adequate and appropriate water shortage mitigation strategies are implemented.	Water Shortage Contingency Planning	Section 6.9
x	x	Section 8.2	10632(a)(2)(A)	Provide the written decision- making process and other methods that the supplier will use each year to determine its water reliability.	Water Shortage Contingency Planning	Section 6.4
x	x	Section 8.2	10632(a)(2)(B)	Provide data and methodology to evaluate the supplier's water reliability for the current year and one dry year pursuant to factors in the code.	Water Shortage Contingency Planning	Section 6.4
x	x	Section 8.3	10632(a)(3)(A)	Define six standard water shortage levels of 10, 20, 30, 40, 50 percent shortage and greater than 50 percent shortage. These levels shall be based on supply conditions, including percent reductions in supply, changes in groundwater levels, changes in surface elevation, or other conditions. The shortage levels shall also apply to a catastrophic interruption of supply.	Water Shortage Contingency Planning	Section 6.5
x	x	Section 8.3	10632(a)(3)(B)	Suppliers with an existing water shortage contingency plan that uses different water shortage levels must cross reference their categories with the six standard categories.	Water Shortage Contingency Planning	n/a
x	x	Section 8.4	10632(a)(4)(A)	Suppliers with water shortage contingency plans that align with the defined shortage levels must specify locally appropriate supply augmentation actions.	Water Shortage Contingency Planning	Section 6.5
x	x	Section 8.4	10632(a)(4)(B)	Specify locally appropriate demand reduction actions to adequately respond to shortages.	Water Shortage Contingency Planning	Section 6.5

Retail	Wholesale	2020 Guidebook Location	Water Code Section	Summary as Applies to UWMP	Subject	2020 UWMP Location (Optional Column for Agency Review Use)
x	x	Section 8.4	10632(a)(4)(C)	Specify locally appropriate operational changes.	Water Shortage Contingency Planning	Section 6.5
x	x	Section 8.4	10632(a)(4)(D)	Specify additional mandatory prohibitions against specific water use practices that are in addition to state-mandated prohibitions are appropriate to local conditions.	Water Shortage Contingency Planning	Section 6.5
x	x	Section 8.4	10632(a)(4)(E)	Estimate the extent to which the gap between supplies and demand will be reduced by implementation of the action.	Water Shortage Contingency Planning	Section 6.10 Table 6-1
x	x	Section 8.4.6	10632.5	The plan shall include a seismic risk assessment and mitigation plan.	Water Shortage Contingency Plan	Section 6.12
x	x	Section 8.5	10632(a)(5)(A)	Suppliers must describe that they will inform customers, the public and others regarding any current or predicted water shortages.	Water Shortage Contingency Planning	Section 6.7
x	x	Section 8.5 and 8.6	10632(a)(5)(B) 10632(a)(5)(C)	Suppliers must describe that they will inform customers, the public and others regarding any shortage response actions triggered or anticipated to be triggered and other relevant communications.	Water Shortage Contingency Planning	Section 6.7
x		Section 8.6	10632(a)(6)	Retail supplier must describe how it will ensure compliance with and enforce provisions of the WSCP.	Water Shortage Contingency Planning	Section 6.6
x	x	Section 8.7	10632(a)(7)(A)	Describe the legal authority that empowers the supplier to enforce shortage response actions.	Water Shortage Contingency Planning	Section 6.1
x	x	Section 8.7	10632(a)(7)(B)	Provide a statement that the supplier will declare a water shortage emergency Water Code Chapter 3.	Water Shortage Contingency Planning	Section 6.1
x	x	Section 8.7	10632(a)(7)(C)	Provide a statement that the supplier will coordinate with any city or county within which it provides water for the possible proclamation of a local emergency.	Water Shortage Contingency Planning	Section 6.1
x	x	Section 8.8	10632(a)(8)(A)	Describe the potential revenue reductions and expense increases associated with activated shortage response actions.	Water Shortage Contingency Planning	Section 6.8
x	x	Section 8.8	10632(a)(8)(B)	Provide a description of mitigation actions needed to address revenue reductions and expense increases associated with activated shortage response actions.	Water Shortage Contingency Planning	Section 6.8
x		Section 8.8	10632(a)(8)(C)	Retail suppliers must describe the cost of compliance with Water Code Chapter 3.3: Excessive Residential Water Use During Drought	Water Shortage Contingency Planning	Section 6.8
x		Section 8.9	10632(a)(9)	Retail suppliers must describe the monitoring and reporting requirements and procedures that ensure appropriate data is collected, tracked, and analyzed for purposes of monitoring customer compliance.	Water Shortage Contingency Planning	Section 6.9
x		Section 8.11	10632(b)	Analyze and define water features that are artificially supplied with water, including ponds, lakes, waterfalls, and fountains, separately from swimming pools and spas.	Water Shortage Contingency Planning	Section 6.4
x	x	Sections 8.12 and 10.4	10635(c)	Provide supporting documentation that Water Shortage Contingency Plan has been, or will be, provided to any city or county within which it provides water, no later than 30 days after the submission of the plan to DWR.	Plan Adoption, Submittal, and Implementation	Section 6.11
x	x	Section 8.14	10632(c)	Make available the Water Shortage Contingency Plan to customers and any city or county where it provides water within 30 after adopted the plan.	Water Shortage Contingency Planning	Section 6.11
	x	Sections 9.1 and 9.3	10631(e)(2)	Wholesale suppliers shall describe specific demand management measures listed in code, their distribution system asset management program, and supplier assistance program.	Demand Management Measures	n/a

Retail	Wholesale	2020 Guidebook Location	Water Code Section	Summary as Applies to UWMP	Subject	2020 UWMP Location (Optional Column for Agency Review Use)
x		Sections 9.2 and 9.3	10631(e)(1)	Retail suppliers shall provide a description of the nature and extent of each demand management measure implemented over the past five years. The description will address specific measures listed in code.	Demand Management Measures	Chapter 7
x		Chapter 10	10608.26(a)	Retail suppliers shall conduct a public hearing to discuss adoption, implementation, and economic impact of water use targets (recommended to discuss compliance).	Plan Adoption, Submittal, and Implementation	Section 1.5 Appendix B
x	x	Section 10.2.1	10621(b)	Notify, at least 60 days prior to the public hearing, any city or county within which the supplier provides water that the urban water supplier will be reviewing the plan and considering amendments or changes to the plan. Reported in Table 10-1.	Plan Adoption, Submittal, and Implementation	Section 1.4 Table 1-2
x	x	Section 10.4	10621(f)	Each urban water supplier shall update and submit its 2020 plan to the department by July 1, 2021.	Plan Adoption, Submittal, and Implementation	Section 1.7
x	x	Sections 10.2.2, 10.3, and 10.5	10642	Provide supporting documentation that the urban water supplier made the plan and contingency plan available for public inspection, published notice of the public hearing, and held a public hearing about the plan and contingency plan.	Plan Adoption, Submittal, and Implementation	Section 1.3 Section 1.4 Section 1.5 Section 1.6 Appendix B
x	x	Section 10.2.2	10642	The water supplier is to provide the time and place of the hearing to any city or county within which the supplier provides water.	Plan Adoption, Submittal, and Implementation	Section 1.6 Appendix B
x	x	Section 10.3.2	10642	Provide supporting documentation that the plan and contingency plan has been adopted as prepared or modified.	Plan Adoption, Submittal, and Implementation	Section 1.6 Appendix B
x	x	Section 10.4	10644(a)	Provide supporting documentation that the urban water supplier has submitted this UWMP to the California State Library.	Plan Adoption, Submittal, and Implementation	Section 1.7
x	x	Section 10.4	10644(a)(1)	Provide supporting documentation that the urban water supplier has submitted this UWMP to any city or county within which the supplier provides water no later than 30 days after adoption.	Plan Adoption, Submittal, and Implementation	Section 1.7
x	x	Sections 10.4.1 and 10.4.2	10644(a)(2)	The plan, or amendments to the plan, submitted to the department shall be submitted electronically.	Plan Adoption, Submittal, and Implementation	Section 1.7
x	x	Section 10.5	10645(a)	Provide supporting documentation that, not later than 30 days after filing a copy of its plan with the department, the supplier has or will make the plan available for public review during normal business hours.	Plan Adoption, Submittal, and Implementation	Section 1.8
x	x	Section 10.5	10645(b)	Provide supporting documentation that, not later than 30 days after filing a copy of its water shortage contingency plan with the department, the supplier has or will make the plan available for public review during normal business hours.	Plan Adoption, Submittal, and Implementation	Section 6.11
x	x	Section 10.6	10621(c)	If supplier is regulated by the Public Utilities Commission, include its plan and contingency plan as part of its general rate case filings.	Plan Adoption, Submittal, and Implementation	n/a
x	x	Section 10.7.2	10644(b)	If revised, submit a copy of the water shortage contingency plan to DWR within 30 days of adoption.	Plan Adoption, Submittal, and Implementation	Section 6.11

Appendix B: Notification and Public Hearing Outreach

- City/County Notification
- Public Hearing outreach – *to be included in final*

Entities who received Notification Letter

Nevada County
Placer County
Yuba County
City of Grass Valley
City of Nevada City
City of Lincoln
Placer County Water Agency
Yuba Water Agency

6 B Estates Water Association
Ali Lane Mutual Water Association
Big Oak Valley Mutual Water Company
Blackford Ranch Water Association
Carmody Special Water District
Chicago Park Water Association
Chili Hill Farms Water Association
Clear Creek Water Association
Cole Country Water Users Association
Countryside Ranch Water Association
Fawn Hill Drive Water Association
Flying R Ranch Water Association
Footehold Estates Water Association
Gold Blossom-Rivera Mutual Water Association
Greenpeace Water Association
HDA Association
Iron Mountain Mutual Water Company
Lake Vera Mutual Water Company
Little Greenhorn Creek Water Association
Meadow Hill Water Association
Melody Oaks Mutual Water Company
Moonshine Water Company
Mount Vernon Estates Mutual Water Company
Mustang Valley Mutual Water Company
Oakcreek Water Association
Ophir Prison Estates Mutual Water
Perimeter Road Pipeline
Quail Hill Acres Rd & Water Systems Association
Redbud Water Association
Ridge View Woodlands Mutual Water Company
Rough & Ready Ranch Estates Mutual Water Company
Rudd Road Pipeline Association
Running Water Inc.
Saddleback North Water Group
Saddleback Water Association
Sierra Foothills Water Association
Sky Pines Mutual Water Association
Streeter Road Water Association
Vian Water Association
Wilkes Pipeline Association



Nevada Irrigation District

December 11, 2020

Jennifer Hanson, City Manager
City of Lincoln
600 6th Street
Lincoln, CA 95648

Dear Jennifer Hanson,

The Nevada Irrigation District (NID) has begun the process of updating its Agricultural Water Management Plan (AWMP) and its Urban Water Management Plan (UWMP) as required by the California Water Code. Because NID is both a municipal drinking water supplier and an agricultural raw water supplier, it is completing both documents which are required to be updated every five years.

The Agricultural Water Management Plan requires an agricultural water provider to present information about its agricultural water customers, water usage, conservation efforts, and other management elements. The AWMP must be adopted by the NID Board of Directors by April 1, 2021.

The Urban Water Management Plan requires all municipal water providers to project its supply and demand over the next 20 years, describe its conservation efforts and impacts, consider drought impacts, describe its water shortage contingency plan, consider indoor and outdoor water budgets, as well as other elements to report progress. The plan is a summary of the water provider's key performance indicators for the next 20 years to support its capabilities to meet customer's demands. The UWMP must be adopted by the NID Board of Directors by July 1, 2021.

NID is notifying you, our customers, and other stakeholders that we have initiated our 2020 AWMP and UWMP update process. As part of the process, NID will hold two public meetings for each plan in the spring to allow public review prior to Board consideration.

Please contact me if you have any questions regarding this notification or NID's AWMP and UWMP update process.

Sincerely,

A handwritten signature in blue ink, appearing to read "Doug Roderick".

Doug Roderick, P.E.
Interim Engineering Manager



Nevada Irrigation District

December 11, 2020

Catrina Olson, City Manager
City of Nevada City
317 Broad Street
Nevada City, CA 95959

Dear Katrina Olson,

The Nevada Irrigation District (NID) has begun the process of updating its Agricultural Water Management Plan (AWMP) and its Urban Water Management Plan (UWMP) as required by the California Water Code. Because NID is both a municipal drinking water supplier and an agricultural raw water supplier, it is completing both documents which are required to be updated every five years.

The Agricultural Water Management Plan requires an agricultural water provider to present information about its agricultural water customers, water usage, conservation efforts, and other management elements. The AWMP must be adopted by the NID Board of Directors by April 1, 2021.

The Urban Water Management Plan requires all municipal water providers to project its supply and demand over the next 20 years, describe its conservation efforts and impacts, consider drought impacts, describe its water shortage contingency plan, consider indoor and outdoor water budgets, as well as other elements to report progress. The plan is a summary of the water provider's key performance indicators for the next 20 years to support its capabilities to meet customer's demands. The UWMP must be adopted by the NID Board of Directors by July 1, 2021.

NID is notifying you, our customers, and other stakeholders that we have initiated our 2020 AWMP and UWMP update process. As part of the process, NID will hold two public meetings for each plan in the spring to allow public review prior to Board consideration.

Please contact me if you have any questions regarding this notification or NID's AWMP and UWMP update process.

Sincerely,

A handwritten signature in blue ink, appearing to read "Doug Roderick".

Doug Roderick, P.E.
Interim Engineering Manager



Nevada Irrigation District

December 11, 2020

Tim M. Kiser, City Manager
City of Grass Valley
125 East Main Street
Grass Valley, CA 95945

Dear Tim M. Kiser,

The Nevada Irrigation District (NID) has begun the process of updating its Agricultural Water Management Plan (AWMP) and its Urban Water Management Plan (UWMP) as required by the California Water Code. Because NID is both a municipal drinking water supplier and an agricultural raw water supplier, it is completing both documents which are required to be updated every five years.

The Agricultural Water Management Plan requires an agricultural water provider to present information about its agricultural water customers, water usage, conservation efforts, and other management elements. The AWMP must be adopted by the NID Board of Directors by April 1, 2021.

The Urban Water Management Plan requires all municipal water providers to project its supply and demand over the next 20 years, describe its conservation efforts and impacts, consider drought impacts, describe its water shortage contingency plan, consider indoor and outdoor water budgets, as well as other elements to report progress. The plan is a summary of the water provider's key performance indicators for the next 20 years to support its capabilities to meet customer's demands. The UWMP must be adopted by the NID Board of Directors by July 1, 2021.

NID is notifying you, our customers, and other stakeholders that we have initiated our 2020 AWMP and UWMP update process. As part of the process, NID will hold two public meetings for each plan in the spring to allow public review prior to Board consideration.

Please contact me if you have any questions regarding this notification or NID's AWMP and UWMP update process.

Sincerely,

Doug Roderick, P.E.
Interim Engineering Manager



Nevada Irrigation District

December 11, 2020

Kevin Mallen, CAO
Yuba County
915 Eighth Street #115
Marysville, CA 95901

Dear Kevin Mallen,

The Nevada Irrigation District (NID) has begun the process of updating its Agricultural Water Management Plan (AWMP) and its Urban Water Management Plan (UWMP) as required by the California Water Code. Because NID is both a municipal drinking water supplier and an agricultural raw water supplier, it is completing both documents which are required to be updated every five years.

The Agricultural Water Management Plan requires an agricultural water provider to present information about its agricultural water customers, water usage, conservation efforts, and other management elements. The AWMP must be adopted by the NID Board of Directors by April 1, 2021.

The Urban Water Management Plan requires all municipal water providers to project its supply and demand over the next 20 years, describe its conservation efforts and impacts, consider drought impacts, describe its water shortage contingency plan, consider indoor and outdoor water budgets, as well as other elements to report progress. The plan is a summary of the water provider's key performance indicators for the next 20 years to support its capabilities to meet customer's demands. The UWMP must be adopted by the NID Board of Directors by July 1, 2021.

NID is notifying you, our customers, and other stakeholders that we have initiated our 2020 AWMP and UWMP update process. As part of the process, NID will hold two public meetings for each plan in the spring to allow public review prior to Board consideration.

Please contact me if you have any questions regarding this notification or NID's AWMP and UWMP update process.

Sincerely,

Doug Roderick, P.E.
Interim Engineering Manager



Nevada Irrigation District

December 11, 2020

Todd Leopold, CEO
Placer County
775 North Lake Blvd.
Tahoe City, CA 96145

Dear Todd Leopold,

The Nevada Irrigation District (NID) has begun the process of updating its Agricultural Water Management Plan (AWMP) and its Urban Water Management Plan (UWMP) as required by the California Water Code. Because NID is both a municipal drinking water supplier and an agricultural raw water supplier, it is completing both documents which are required to be updated every five years.

The Agricultural Water Management Plan requires an agricultural water provider to present information about its agricultural water customers, water usage, conservation efforts, and other management elements. The AWMP must be adopted by the NID Board of Directors by April 1, 2021.

The Urban Water Management Plan requires all municipal water providers to project its supply and demand over the next 20 years, describe its conservation efforts and impacts, consider drought impacts, describe its water shortage contingency plan, consider indoor and outdoor water budgets, as well as other elements to report progress. The plan is a summary of the water provider's key performance indicators for the next 20 years to support its capabilities to meet customer's demands. The UWMP must be adopted by the NID Board of Directors by July 1, 2021.

NID is notifying you, our customers, and other stakeholders that we have initiated our 2020 AWMP and UWMP update process. As part of the process, NID will hold two public meetings for each plan in the spring to allow public review prior to Board consideration.

Please contact me if you have any questions regarding this notification or NID's AWMP and UWMP update process.

Sincerely,

Doug Roderick, P.E.
Interim Engineering Manager



Nevada Irrigation District

December 11, 2020

Allison Lehman, CEO
Nevada County
950 Maidu Avenue
Nevada City, CA 95969

Dear Allison Lehman,

The Nevada Irrigation District (NID) has begun the process of updating its Agricultural Water Management Plan (AWMP) and its Urban Water Management Plan (UWMP) as required by the California Water Code. Because NID is both a municipal drinking water supplier and an agricultural raw water supplier, it is completing both documents which are required to be updated every five years.

The Agricultural Water Management Plan requires an agricultural water provider to present information about its agricultural water customers, water usage, conservation efforts, and other management elements. The AWMP must be adopted by the NID Board of Directors by April 1, 2021.

The Urban Water Management Plan requires all municipal water providers to project its supply and demand over the next 20 years, describe its conservation efforts and impacts, consider drought impacts, describe its water shortage contingency plan, consider indoor and outdoor water budgets, as well as other elements to report progress. The plan is a summary of the water provider's key performance indicators for the next 20 years to support its capabilities to meet customer's demands. The UWMP must be adopted by the NID Board of Directors by July 1, 2021.

NID is notifying you, our customers, and other stakeholders that we have initiated our 2020 AWMP and UWMP update process. As part of the process, NID will hold two public meetings for each plan in the spring to allow public review prior to Board consideration.

Please contact me if you have any questions regarding this notification or NID's AWMP and UWMP update process.

Sincerely,

A handwritten signature in blue ink, appearing to read "Doug Roderick".

Doug Roderick, P.E.
Interim Engineering Manager



Nevada Irrigation District

December 11, 2020

Andy Fecko, General Manager
Placer County Water Agency
P.O. Box 6570
Auburn, CA 95604

Dear Andy Fecko,

The Nevada Irrigation District (NID) has begun the process of updating its Agricultural Water Management Plan (AWMP) and its Urban Water Management Plan (UWMP) as required by the California Water Code. Because NID is both a municipal drinking water supplier and an agricultural raw water supplier, it is completing both documents which are required to be updated every five years.

The Agricultural Water Management Plan requires an agricultural water provider to present information about its agricultural water customers, water usage, conservation efforts, and other management elements. The AWMP must be adopted by the NID Board of Directors by April 1, 2021.

The Urban Water Management Plan requires all municipal water providers to project its supply and demand over the next 20 years, describe its conservation efforts and impacts, consider drought impacts, describe its water shortage contingency plan, consider indoor and outdoor water budgets, as well as other elements to report progress. The plan is a summary of the water provider's key performance indicators for the next 20 years to support its capabilities to meet customer's demands. The UWMP must be adopted by the NID Board of Directors by July 1, 2021.

NID is notifying you, our customers, and other stakeholders that we have initiated our 2020 AWMP and UWMP update process. As part of the process, NID will hold two public meetings for each plan in the spring to allow public review prior to Board consideration.

Please contact me if you have any questions regarding this notification or NID's AWMP and UWMP update process.

Sincerely,

A handwritten signature in blue ink, appearing to read "Doug Roderick".

Doug Roderick, P.E.
Interim Engineering Manager



Nevada Irrigation District

December 11, 2020

Willie Whittlesey, General Manager
Yuba Water Agency
1220 F Street
Marysville, CA 95901

Dear Willie Whittlesey,

The Nevada Irrigation District (NID) has begun the process of updating its Agricultural Water Management Plan (AWMP) and its Urban Water Management Plan (UWMP) as required by the California Water Code. Because NID is both a municipal drinking water supplier and an agricultural raw water supplier, it is completing both documents which are required to be updated every five years.

The Agricultural Water Management Plan requires an agricultural water provider to present information about its agricultural water customers, water usage, conservation efforts, and other management elements. The AWMP must be adopted by the NID Board of Directors by April 1, 2021.

The Urban Water Management Plan requires all municipal water providers to project its supply and demand over the next 20 years, describe its conservation efforts and impacts, consider drought impacts, describe its water shortage contingency plan, consider indoor and outdoor water budgets, as well as other elements to report progress. The plan is a summary of the water provider's key performance indicators for the next 20 years to support its capabilities to meet customer's demands. The UWMP must be adopted by the NID Board of Directors by July 1, 2021.

NID is notifying you, our customers, and other stakeholders that we have initiated our 2020 AWMP and UWMP update process. As part of the process, NID will hold two public meetings for each plan in the spring to allow public review prior to Board consideration.

Please contact me if you have any questions regarding this notification or NID's AWMP and UWMP update process.

Sincerely,

A handwritten signature in blue ink, appearing to read "Doug Roderick".

Doug Roderick, P.E.
Interim Engineering Manager

Entities who received Press Release

Wildlife.ca/gov

USDA.gov

Yubariver.org

Placer County Agricultural Commissioner

Nevada County Agricultural Commissioner

Nevada County Farm Bureau

Placer County Farm Bureau

LWWA.org

Sen.ca

wildlife.ca.org

The Union

Bear Yuba Land Trust (BYLT)

NID Agricultural Customers



Contact: Tomi Riley
(530) 271-6845
RileyT@nidwater.com

FOR IMMEDIATE RELEASE

**NID Preparing Agricultural and Urban Water Management Plans
Due to the State in 2021**

(Grass Valley, CA December 11, 2020) – The Nevada Irrigation District (NID) is preparing its 2020 Agricultural Water Management Plan (AWMP) and 2020 Urban Water Management Plan (UWMP) as required by the California Water Code. Because NID is both a municipal drinking water supplier and an agricultural raw water supplier it submits both documents.

The Urban Water Management Plan (UWMP) requires all municipal water providers to project its supply and demand over the next 20 years, describe its conservation efforts and impacts, consider drought impacts, describe its water shortage contingency plan, consider indoor and outdoor water budgets, as well as other elements to report progress. The plan is functionally a summary of the water provider's key performance indicators for the next 20 years to support its capabilities to meet its customer's demands. The plan is due to the state every five years, with the next plan due June 30, 2021.

The Agricultural Water Management Plan (AWMP) is similar to the Urban Water Management Plan as both are state-mandated reports due every five years. The AWMP requires an agricultural water provider to present information about its agricultural water customers, water usage, conservation efforts, and other management elements. The AWMP is also due to the state every five years, with the next plan due July 1, 2021.

NID wants our customers and other stakeholders to know that NID has initiated its 2020 AWMP and UWMP update process. As part of the process, NID will hold two public meetings for each plan to allow public input prior to Board adoption consideration. Draft copies of each plan will be available for review in the spring of 2021.

For additional information about the Nevada Irrigation District's AWMP and UWMP update process, please visit NIDwater.com

Appendix C: 2020 UWMP and WSCP Adoption Resolutions

To be included in final

Appendix D: NID Conservation Information

Community Outreach





FREE

Irrigation Workshop

Learn :

- *What is a miners inch of water;*
- *How much water do you actually need;*
- *How to design an effective irrigation system;*
- *How to efficiently schedule your irrigation;*
- *When and how much water to apply;*
- *How to check for soil moisture;*
- *How to check the pressure on your system;*
- *How to make your irrigation water apply uniformly;*
- *How to conserve water*

Friday
June 26, 2015
8 am to 2 pm

Or

Saturday
June 27, 2015
8 am to 2 pm

Workshop will be held
at a private ranch in
Auburn CA
Call for details

*****Participants Must Preregister*****



Bring a chair, sack lunch, walking shoes and sunscreen
Light refreshments will be provided

For information or to register please contact:
530-273-6185 Ext 286 or tipton@nidwater.com

Space Is Limited To 30 Participants Per Class

Fabulous Tour of Agriculture in Nevada County!! Lunch Included!



Tour of Nevada County Agriculture June 11th



You are invited to an outstanding educational tour of the proposed Parker Dam site. We will tour a water treatment plant as well as learn about NID water services upgrades for Nevada County.

Contact :
346-8146 or
ncfb.manager@gmail.com
for more information

**Cost: \$20 for Farm Bureau Members-\$30 for non members,
Online @ nevadacountyfarmbureau.com**

***Reserve your space by June 6, 2015 -SPACE IS LIMITED -
Reservations are REQUIRED***

Check in at 8:30 am @ Bear River High School

Irrigated Pasture Management Workshop

**Saturday
April 16, 2016
9 am to Noon**

Workshop will be held at
a private ranch in
Penn Valley CA
Call for details

Learn how to maintain your pasture and improve water management and system efficiency. This workshop features indoor and outdoor presentations.

Topics include :

- Understanding the physical and biological characteristics of your soil
- Estimating soil moisture
- Types of sprinkler and flood pasture irrigation
- Irrigation management and scheduling to improve efficiency
- Fertilization strategies
- Irrigated pasture forages commonly planted
- Grazing management practices for irrigated pastures

SPONSORED BY:



Nevada County
Resource Conservation District
Your partner in conservation & agriculture

University of California
Agriculture and Natural Resources

*Featuring presenter Roger Ingram,
UCCE County Director and Farm Advisor*

*****Participants Must Preregister*****

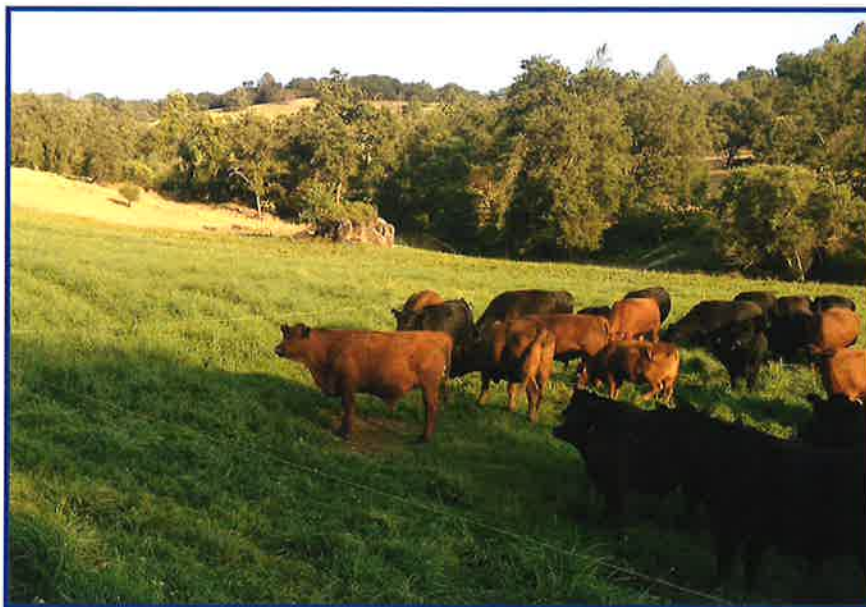

**Bring a chair, walking shoes and sunscreen
Light refreshments will be provided**

For information or to register please contact:

530-273-6185 Ext 286 or tipton@nidwater.com

Space Is Limited

**Saturday
April 29, 2017
9 am to Noon**

**Workshop will be held
at a private ranch in
Penn Valley CA**

Call for details

Irrigated Pasture Management Workshop

Learn how to maintain your pasture and improve water management and system efficiency. This workshop features indoor and outdoor presentations.

Topics include :

- Understanding the physical and biological characteristics of your soil
- Estimating soil moisture
- Types of sprinkler and flood pasture irrigation
- Irrigation management and scheduling to improve efficiency
- Fertilization strategies
- Irrigated pasture forages commonly planted
- Grazing management practices for irrigated pastures

SPONSORED BY:



NID



Nevada County
Resource Conservation District
Your partner in conservation & agriculture

University of California
Agriculture and Natural Resources

*Featuring presenter Roger Ingram,
UCCE County Director and Farm Advisor*

*****Participants Must Preregister*****

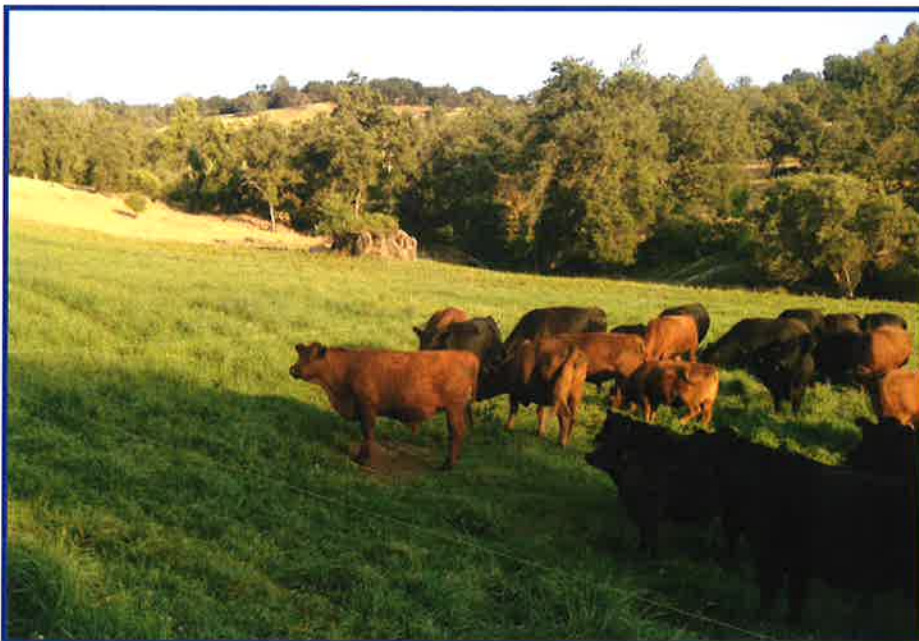

Bring a chair, walking shoes and sunscreen

Light refreshments will be provided

For more information or to register please call 530-798-5530

Register online @ www.ncrcd.org or email sabrina.nicholson@ncrcd.org

Space Is Limited



SATURDAY

September 30th, 2017

Clean Up 9am-11am | CreekFest 11am-2pm

McBean Park, Lincoln

Join us!

DEMONSTRATIONS & EXHIBITS
VENDORS | ARTS & CRAFTS
BOUNCE HOUSES & FACE PAINTING
FOOD | GAMES & PRIZES



www.wildlifeheritage.org/creekfest

8th Annual



S U S T A I N A B L E

FOOD & FARM

C O N F E R E N C E

February 9-11, 2018

Grass Valley, California

FEATURING:

Joel Salatin

Regenerative Farming & Ranching

Elizabeth & Paul Kaiser

No Till, High Yield Organic Farming

Daphne Miller, M.D.

Healthy Soil, Healthy You

Three overlapping green circles with white borders are arranged in a cluster. The top circle contains the number "20" in a large font, with "Food & Farm Workshops" written below it. The bottom-left circle contains the text "Farm Tours". The bottom-right circle contains the text "In-Depth Lectures".

www.FoodandFarmConference.com



*"...a world class event
at a fraction of the cost
that many conferences
of its caliber usually
charge."*

- Joel Salatin

Who: The **Sustainable Food & Farm Conference** is organized by Sierra Harvest and a committee of local farmers and ranchers. In its 8th year, the conference is expected to draw over 500 attendees from Northern California and beyond, including farmers, ranchers, gardeners, homesteaders and foodies.

Why: The **Sustainable Food & Farm Conference** brings together internationally acclaimed keynote speakers and local experts to expand and strengthen the sustainable farming movement, to help farmers create more successful businesses, and to foster a sense of community among those engaged in the sustainable food and farming movement.

Value of Sponsorship:

- Have your logo on conference marketing materials.
- Advertise your products and services to this targeted audience.
- Attract new customers and connect with existing customers through a vendor booth at the Food and Farm Expo.
- Support farm conference scholarships for local farmers.
- Show your support for the local sustainable agricultural movement.
- Help us keep admission prices affordable.
- Free tickets for both days of the conference.



AgTech 2018 Micro Conference

Connecting people, ideas and
resources at the intersection
of agriculture and technology

For complete details and
registration information, visit:
nctechconnection.org/agtech18

FREE OF CHARGE

February 9 - 12:30-5pm
(registration opens at 11am)

**104 New Mohawk Road,
Nevada City 95959**



**Thank you
to our sponsors!**

**BRIARPATCH
FOOD CO OP**



KEYNOTE SPEAKER:

GABRIEL YOUTSEY, Chief Innovation Officer at University of California, Agriculture and Natural Resources

PRESENTERS:

WILLA LEONG, Attorney: Royse Law Firm
ROBERT TSU, California State Broadband Coordinator
JOHN SELEP: Founder of AgTech Innovation Partners

PANELISTS:

STEVEN DAVIS (Moderator): CEO at I W N, Inc.
MOLLY NAKAHARA: Sierra Harvest, Farm Institute
Director & owner, Dinner Bell Farm
CHRIS CLABAUGH: Co-founder Grass Valley Growing
DAN MACON: Uc Cooperative Extension
SUSIE SUPTHIN, Director: Tahoe Food Hub
ERIC BLEAU, Manager: Blue Oaks Ranch

2nd Annual
**BUILDING
FAIR**

Concept to Creation
“Success from Start to Finish”

Friday - June 2, 2017

9:00am - 1:00pm

**Rood Government Center
950 Maidu Ave, Nevada City, CA**

Sponsored By
County of Nevada
Nevada County Contractors' Association (NCCA)
Nevada County Association of Realtors (NCAOR)

County & Local Agencies * Building Material Suppliers/Equipment Rentals
Building Contractors * Construction Lenders * Design Professionals
Septic/Well * Industry Representatives * Utility Companies
Manufactured Housing * Insurance * Solar Companies and many more...

**Special Presentations, Booths, Opportunity Drawings,
Food Trucks and much more... Fair Admission is FREE**

**For more information contact the Nevada County Building Department at
(530) 265-1222 or email at BuildingDept@co.nevada.ca.us**

IRRIGATED PASTURE MANAGEMENT WORKSHOP

Learn how to maintain your pasture and improve water management and system efficiency. This workshop features indoor and outdoor presentations.

Topics include:

- Understanding the physical and biological characteristics of your soil
- Estimating soil moisture
- Types of sprinkler and flood pasture irrigation
- Irrigation management and scheduling to improve efficiency
- Fertilization strategies
- Irrigated pasture forages commonly planted
- Grazing management practices for irrigated pastures

**** Participants Must Pre-register ****



*Featuring presenter Dan Macon,
UCCE Livestock and Natural Resources Advisor*

For more information or to register
please contact Kaycee Strong
530-273-6185 ext. 244 strongk@nidwater.com

**Saturday
May 19, 2018
8am-11:30 am**

Workshop will be held at a
private ranch in

Penn Valley, Ca

Call for details

SPONSORED BY:



NID



Nevada County
Resource Conservation District
www.ncrcd.org

**University of California
Agriculture and Natural Resources**

***Bring a chair, walking
shoes and sunscreen.***

***Light refreshments will
be provided.***

2018 BUILDING FAIR

3RD ANNUAL

BUILDING BLOCKS FOR SUCCESS

Friday
June 1st
12 to 4

SAVE
THE
DATE!



SPONSORED BY



Meet experts from all
trades of construction,
real estate, material
suppliers & much more!

- ★ INFORMATION HUB
- ★ PROJECT IDEAS
- ★ DEMOS
- ★ FOOD VENDORS

LOCATION: 950 MAIDU AVE, NEVADA CITY, CA 95959

For questions regarding the event, please contact the Nevada County Building
Department at 530.265.1222 or buildingdept@co.nevada.ca.us



Community Wildfire Preparedness Day

May 5, 2018 -12-4pm - 950 Maidu Avenue, Nevada City



LIVE Fire Demonstrations by PHOS-CHeK Fire Retardant

Pet Microchipping

Learn to be Firewise

BBQ Lunch

Fire Engine Display

American Red Cross

Photos with Smokey Bear

American Red Cross

Live Music by The Public Safety Band

\$500 Grant to the Firewise Community signing in the most guests!



SPONSORED BY:



Photo: Lobo Fire, October 2017

You Are Invited!



The STEAM Expo is presented by the Nevada County Superintendent of Schools office in order to promote 21st Century STEAM education in our county and to link these educational goals with career opportunities provided by local businesses and organizations.

Date: Saturday, April 7, 2018

Location: Main Street Center, Nevada County Fairgrounds

Time: 9 a.m. – 3 p.m. **Cost:** FREE - all ages welcome **Info:** nevcoexpo.org

See AWESOME student projects from nearly every Nevada County school!

Here are just some of the other things you can enjoy . . .

Play with robots * Experience virtual reality * Get a free bike tune-up

Make a bike-powered smoothie * Program a Sphero

Deepen your environmental awareness * Look at critters through a microscope

See works of visual and performing art * Try musical instruments

Sign up for a library card * Check out STEAM books from the library

Use green screen technology * Use a catapult * Create a hot air balloon

Create a Magic Mirror * Use Mousebots * Make marble runs

Use a Van de Graff generator * Participate in a robotics cone stacking challenge

Use a 3D printer * Learn about river science * Learn about astronomy

Create your own art * Purchase delicious food and beverages from local vendors



IRRIGATED PASTURE MANAGEMENT WORKSHOP

Learn how to maintain your pasture and improve water management and system efficiency. This workshop features indoor and outdoor presentations.

Participants Must Pre-register

Topics include:

- Understanding the physical and biological characteristics of your soil
- Estimating soil moisture
- Types of sprinkler and flood pasture irrigation
- Irrigation management and scheduling to improve efficiency
- Fertilization stages
- Commonly planted irrigated pasture forages
- Grazing management practices on irrigated pastures

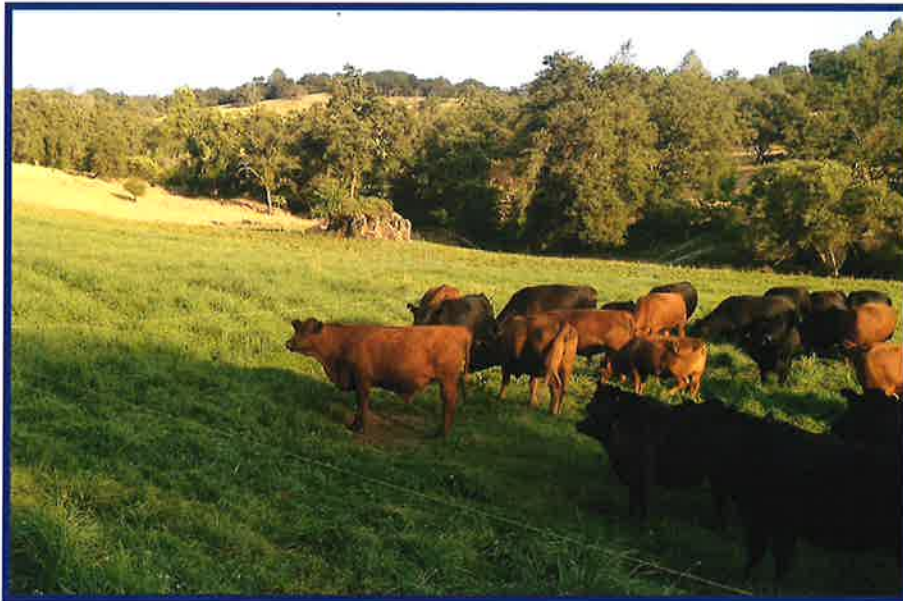

**Featuring presenter Dan Macon,
UCCE Livestock and Natural Resources Advisor**

For more information or to register
please contact Kaycee Strong
530-273-6185 ext. 244 strongk@nidwater.com

Saturday

May 4, 2019

8 am—11:30 am

Workshop will be held at a
private ranch in

Penn Valley, Ca

Call or email for details

SPONSORED BY:



NID



Nevada County
Resource Conservation District
www.ncrcd.org

University of California
Agriculture and Natural Resources

***Bring a chair, walking
shoes and sunscreen.***

***Light refreshments will
be provided.***

9TH ANNUAL



S U S T A I N A B L E

FOOD & FARM

C O N F E R E N C E

February 8-10, 2019

GRASS VALLEY, CALIFORNIA

FEATURING:

Doniga Markegard

Regenerative Rancher

Jeff Lowenfels

Mycorrhizal Fungi Soil Food Web Expert

Dru Rivers & Paul Muller

Full Belly Farm Collaborative Farmers

20
Food & Farm
Workshops

**Farm
Tours**

**In-Depth
Lectures**



foodandfarmconference.com • 530.265.2343



*"...a world class event
at a fraction of the cost
that many conferences
of its caliber usually
charge."*

- Joel Salatin
2018 Keynote Speaker

Who: The **Sustainable Food & Farm Conference** is organized by Sierra Harvest and a committee of local farmers and ranchers. In its 9th year, the conference is expected to draw over 600 attendees from Northern California and beyond, including farmers, ranchers, gardeners, homesteaders and foodies.

Why: The **Sustainable Food & Farm Conference** brings together internationally acclaimed keynote speakers and local experts to expand and strengthen the sustainable farming movement, to help farmers create more successful businesses, and to foster a sense of community among those engaged in the sustainable food and farming movement.

Value of Sponsorship:

- Have your logo on conference promotional materials.
- Advertise your products and services to this targeted audience.
- Attract new customers and connect with existing customers through a vendor booth at the Food and Farm Expo.
- Support farm conference scholarships for farmers.
- Show your support for the local sustainable agricultural movement.
- Keep admission prices affordable.
- Free tickets for both days of the conference.

Join us at Nevada County's premiere home, garden and lifestyle expo as we celebrate

34 years!

Sat. April 13th, 2019 • 10-5
Sun. April 14th, 2019 • 10-4

Grass Valley, California
Nevada County Fairgrounds

THIS YEAR'S
FOCUS
Fire
Safety

THE UNION'S 34th ANNUAL
**HOME
GARDEN
& Lifestyle
SHOW**

Reach your best prospects and connect with your customers at Nevada County's Premiere Home, Garden and Lifestyle Expo!

Build Your Business in just 2 days!

- Meet motivated consumers
- Generate immediate sales and qualified leads
- Introduce new products and services
- Conduct market research
- Build brand awareness
- Maximize your marketing budget by allowing the power of The Union's significant household reach to drive leads

How The Union markets your presence at our show:

- Extensive print advertising campaign in The Union
- Online advertising on theunion.com
- Social media marketing
- Radio advertising plus live radio broadcast from the Home Show
- Banners and posters in local and surrounding areas
- Print advertising in popular regional publications
- Special Home, Garden & Lifestyle publication distributed in The Union a few days prior to show, and given to attendees at the event
- Email marketing to subscribers and past show attendees
- Posters/flyers at vendors business locations

Featuring:

- Sponsorship opportunities available
- Demonstration Stage
- Bonsai Club Exhibit
- Live Entertainment
- Delicious Food Court
- Free Admission

Special focus on being Fire Wise

Please promote your products or services that fit the theme if you have them.



Build your business at Western Nevada County's **ONLY** home and garden expo

- Exposure to thousands of area homeowners
- Listing on theunion.com/homeshow – includes business name and link to website
- 25% off advertising in Home, Garden & Lifestyle publication
- Free vendor listing in publication that includes your product/ service description
- Opportunities to participate in additional marketing for your business at no cost to you – including live radio broadcast, business profiles and more



We find The Union's Home, Garden & Lifestyle Show to be one of the best we do each year. It is professionally operated and we get a lot of very solid leads that often turn into customers. It also gives us a chance to reconnect with past clients to continue building those relationships. I highly recommend this show."

~ Andrew B. Twidwell, Owner of ABT Plumbing, Electric, Heat & Air



We do five shows a year, and The Union's Home and Garden Show has the best turnout and also brings us the most qualified leads of them all. Over 75% of our leads turn into business because the attendees at this show are serious buyers – rain or shine! We will always participate in the Grass Valley show."

~ Elisa Hawkins, Owner of Affordable Painting

THIS YEAR'S
FOCUS
Fire
Safety

To apply for vendor space, download application at theunion.com/homeshow or email Mary Anne Davis at mdavis@theunion.com or call 530.477.4241



THE UNION
www.TheUnion.com
Great People Connecting Communities

The Union Newspaper
464 Sutton Way
Grass Valley, CA 95945



FOOD & FARM

CONFERENCE

FEBRUARY 7

GRASS VALLEY

FEATURING

Dr. Vandana Shiva
Food Sovereignty
Activist & Author

**Paul & Elizabeth
Kaiser**
No-Till, Climate-Smart
Ecological Farmers

Jim Gerrish
Profitable Rancher,
Grazing For Soil Health



*Thank you
NID
brigade Jim
Gerrish. He was
fabulous!
- Sierra
+620
attendees*

REGISTER TODAY!

FoodandFarmConference.com

or 530.265.2343

NID: Customers Are Saving Water

January 14, 2015

Contact:

Rem Scherzinger
(530) 273-6185
or: Dave Carter
(530) 265-NEWS

FOR IMMEDIATE RELEASE:

GRASS VALLEY – Nevada Irrigation District General Manager Rem Scherzinger on Wednesday (Jan. 14) thanked NID water users for significant savings of water during the 2014 drought year.

“Year-end figures show that our treated water users reduced their use by 16.5 percent from 2013 levels,” Scherzinger announced at Wednesday’s meeting of the NID Board of Directors. “Our savings is about 10 percent more than the state average. District customers know the drought is serious and are doing their part.”

While expressing concern over the recent stretch of dry weather, Scherzinger said December’s wet weather allowed NID to boost storage in district reservoirs. He said current storage is at 69 percent of capacity.

NID’s 10 reservoirs are now holding nearly 180,000 acre-feet of water, which is up about 25,000 acre-feet from this time last year.

Scherzinger said it appears likely that drought conditions will continue through 2015. He is still asking all customers to maintain their conservation efforts until the drought is over.

In other business, the NID board:

- learned that the Federal Energy Regulatory Commission (FERC) has tentatively approved the district’s environmental studies for the federal relicensing of the NID Yuba-Bear Hydroelectric Project, but that NID’s new license may not be issued until certain progress is made on relicensing studies of the Yuba County Water Agency. NID’s original 50-year license lapsed in 2013 and the project continues to operate under a temporary license.
- agreed to budget funds toward the planning of a waterline extension project on Brewer Road, Armstrong Road and Iron Horse drive in southern Nevada County where 15 landowners have petitioned and agreed to share in the costs of bringing treated water service to their neighborhood.

The next regular meeting of the NID Board of Directors will be held at 9 a.m. on Wednesday, Jan. 28, at the NID Business Center in Grass Valley. NID board meetings are open to the public.

Filed under:

[NID Drought News / Updates](#), [Press Releases](#) by NID Administrator

NID: Water Storage Good, Concern Over Dry Spell

January 28, 2015

Contact:

Rem Scherzinger
(530) 273-6185
or: Dave Carter
(530) 265-NEWS

FOR IMMEDIATE RELEASE:

NID: Water Storage Good, Concern Over Dry Spell

GRASS VALLEY – With January poised to close as the driest January in 128 years of record-keeping, the Nevada Irrigation District is preparing for another year of drought.

“We had a very good December and we were able to put some water in the bank, but January has been one of the driest ever,” said NID Water Operations Manager Chip Close on Wednesday (Jan. 28) in a water supply update to the NID Board of Directors.

The month of December produced 141 percent of average precipitation at NID’s Bowman Reservoir (elev. 5,650 ft.) but the region has remained dry through January, which is normally one of the wettest months of the year.

Carryover storage from last year and the large December storms allowed NID to build water storage to 183,900 acre-feet, which is 112 percent of average for the date and 69 percent of capacity.

“In the past two years, February and March have been our wettest months, so we’re hoping for some significant precipitation,” said Close. “But it’s looking more and more likely that we’re in for another drought year.”

The most troubling statistic, Close said, is a thin mountain snowpack that holds just 29 percent of average water content. In the annual Feb. 1 snow survey, conducted Monday (Jan. 26), NID snow surveyors measured five mountain snow courses, recording an average water content of six inches when the average Feb. 1 water content is 20 inches.

Close said the State Water Board has advised water purveyors, including NID, that if the drought persists, water right curtailment orders along with other mandatory actions may be reinstated to allocate limited water supplies.

The previous curtailment order, issued last May 27, ordered agencies, including NID, to stop diverting water from streams and rivers into storage so more water could flow to downstream areas. NID officials remain concerned that some water the district would normally store will have to run through the NID system to other areas.

Close said NID has begun planning for dry year operations and continues to encourage all customers to reduce water use by 20 percent or more.

In other business, NID directors:

- awarded a \$1.07 million design-build contract to Syblon Reid Construction, Inc. for the installation of new valves and piping at the outlet of the dam at Bowman Reservoir. The work is the second phase of a project to repair and upgrade a damaged old outlet that dates to the dam's construction in 1925-26.

The next regular meeting of the NID Board of Directors will be held at 9 a.m. on Feb. 11 at the NID Business Center in Grass Valley. NID board meetings are open to the public.

-30-

Filed under:

[NID Drought News / Updates](#), [Press Releases](#) by NID Administrator

NID: Weekend Storm Boosts Water Storage

February 11, 2015

Contact:

Rem Scherzinger
(530) 273-6185
or: Dave Carter
(530) 265-NEWS

FOR IMMEDIATE RELEASE:

NID: Weekend Storm Boosts Water Storage

GRASS VALLEY – The weekend storms of Feb. 6-9 brought an average 7 inches of precipitation to Nevada Irrigation District high alpine watershed and boosted NID water storage by about 18,000 acre-feet (an acre-foot equals one acre covered one foot deep).

While the storms produced significant precipitation, it was not enough to ease ongoing drought concerns, NID Water Operations Manager Chip Close reported at Wednesday's (Feb. 11) meeting of the NID Board of Directors.

NID continues to ask all customers to reduce water use by 20 percent. This is the same amount requested by Gov. Brown, who in 2014 declared a drought emergency and this year extended the declaration for second year, to May 2016.

Close said that with several weeks remaining in the rainfall year, conditions could improve. He noted that NID normally waits until April 1 to make determinations on water availability for the coming irrigation season.

NID will be mailing its annual irrigation water applications next week (mid-February) and will ask customers to consider voluntary water reductions for the year. Close said customers who take reductions would not lose priority in future years.

Although this year's storms have been few and far between, they have produced 92 percent of average precipitation and have boosted NID reservoirs to 78 percent of total capacity.

The area of most concern to NID water planners is a thin mountain snowpack, which is the result of this year's warmer than average storms. The district's Feb. 1 snow survey showed just 29 percent of average water content in the mountain snowpack. The March and April snow surveys are expected to provide a much clearer picture on this year's water supplies.

For now, NID is continuing its dry year planning and is operating its water systems very conservatively, holding as much water as possible in storage, said Close.

In other business, NID directors:

- awarded a \$444,600 contract to Olympus and Associates, Inc. of Reno for the interior and exterior repainting of two large steel water storage tanks near Nevada City. The firm submitted the lowest bid among three received by the district. Officials noted that painting and maintaining NID's 42 steel storage tanks is a considerable ongoing expense.

The next regular meeting of the NID Board of Directors will be held at 9 a.m. on Feb. 25 at the NID Business Center in Grass Valley. NID board meetings are open to the public.

-30-

Filed under:

[NID Drought News / Updates](#), [Press Releases](#) by NID Administrator

NID Measures 16% of Average Water Content in Mountain Snowpack

February 27, 2015



This Feb. 24 aerial photo shows little snow on NID mountain watershed. Pictured is the Canyon Creek watershed looking upstream toward Faucherie and French reservoirs.

Contact:

Chip Close

(530) 273-6185

or: Dave Carter

(530) 265-NEWS

FOR IMMEDIATE RELEASE:

(with photo)

NID Measures 16% of Average Water Content in Mountain Snowpack

GRASS VALLEY – In snow surveys taken Tuesday (Feb. 24), the Nevada Irrigation District measured 16 percent of average water content in the mountain snowpack that supplies the NID water system.

“The results are disappointing but not surprising given the weather patterns we have seen,” said NID Water Resources Superintendent Sue Sindt, who noted the region could be facing a fourth straight dry year.

“There is still time for the weather to change and add to the snowpack, but at this time the lack of snow remains a concern for the district,” she said.

Sindt noted that Gov. Brown’s statewide drought declaration remains in effect for a second year and that NID is continuing to ask all water customers to reduce water use by 20 percent.

In this week’s official March 1 snow surveys, NID snow surveyors measured water content in the snowpack on six designated snow courses ranging in elevation from 4,850 feet to 7,800 feet. The five higher elevation snow courses held an average water content of 4.7 inches, which compares to the March 1 average water content of 28.8 inches.

NID's highest course, Webber Peak, at 7,800 feet, had 27.7 inches of snow with a water content of 11.3 inches. The English Mountain snow course (7,100 ft.) had 12.6 inches of snow with a water content of 5.7 inches.

Webber Lake (7,000 ft.) had 14.9 inches of snow with a water content of 5.9 inches. Findley Peak (6,500 ft.) had a snowpack of 1.8 inches and a 0.7-inch water content. Bowman Reservoir (elev. 5650 ft.) had no snow. There also was no snow on the lower elevation Chalk Bluff snow course on the Deer Creek watershed.

This year's precipitation at Bowman Reservoir measured 38.01 inches, or 82 percent of average, as of Feb. 24, but this year's storms have been warmer than usual and have not built a deep snowpack.

NID is continuing its conservative water management to bolster water storage for the coming summer season. As of Feb. 24, the district's reservoirs held 201,500 acre-feet of water, which is 79 percent of capacity.

The NID Board of Directors is expected to review this season's water availability on Mar. 25 and determine what levels of the district's Drought Contingency Plan may have to be enacted this year.

A member of the California Cooperative Snow Survey, NID conducts four official snow surveys each year, in February, March, April and May. Results of the snow surveys are used to predict water availability locally and statewide.

-30-

Filed under:

With Scant Snowpack, NID Considers Drought Plan

March 12, 2015

Contact:

Rem Scherzinger

(530) 273-6185

or: Dave Carter

(530) 265-NEWS

FOR IMMEDIATE RELEASE:

With Scant Snowpack,
NID Considers Drought Plan

GRASS VALLEY – With the mountain snowpack at near-record low levels, Directors of the Nevada Irrigation District are formulating plans for implementation of the district’s Drought Contingency Plan.

In a water supply update to the NID Board on Wednesday (Mar. 11), NID General Manager Rem Scherzinger said that with minimal snowpack runoff to replenish them, NID’s mountain reservoirs are expected to drop rapidly this year.

Although precipitation at Bowman Reservoir (elev. 5,650 ft.) is 79 percent of average, this winter’s warm storms have produced more rain than snow. NID relies on the snowpack as an added reservoir, Scherzinger said.

NID’s March 1 snow surveys found an average snowpack water content of just 4.7 inches, which is 16 percent of the March 1 historical average of 28.8 inches.

District officials are awaiting actions by the State Water Board, which on Mar. 17 may call for mandatory conservation measures for urban water users throughout the state along with tracking and reporting requirements for water agencies.

During last year’s water shortage, NID called for all water users to voluntarily reduce water usage by 20 percent, the same amount as called for in Gov. Brown’s 2014 drought emergency declaration. The 20 percent reduction measures remain in effect locally and statewide.

NID Water Operations Manager Chip Close said staff will follow this month’s Water Board directives and prepare recommendations for the NID Board’s next meeting on Mar. 25. Last year, NID enacted Stage II of its drought plan; this year Stage III mandatory conservation measures could become necessary.

On a related note, the district in early March mailed its annual applications to about 4,500 seasonal irrigation water users. As they have the past two years, a number of these customers have agreed to reduce their water allotments for the year.

Close clarified what appeared to be conflicting information in the application packet. “We want all of our customers to know that if they give up some water this year to help us through the drought, they will not lose their priority to receive their normal amounts in years to come,” he explained.

NID is continuing its dry year operating plan, running its water systems very conservatively, and holding as much water as possible in storage, said Close.

In other business, NID directors:

- held a public workshop as part of a process to update the district's strategic plan. Several members of the public were invited to join NID directors and staff in the planning discussion.

The next regular meeting of the NID Board of Directors will be held at 9 a.m. on Mar. 25 at the NID Business Center in Grass Valley. NID board meetings are open to the public.

-30-

Filed under:

[NID Drought News / Updates](#), [Press Releases](#) by NID Administrator

NID Adopts Drought Plan; Calls for 20% Conservation

March 25, 2015

Contact: Rem Scherzinger (530) 273-6185 or: Dave Carter (530) 265-NEWS FOR IMMEDIATE RELEASE:

Directors of the Nevada Irrigation District on Wednesday (Mar. 25) adopted a series of drought measures that include limits on outdoor watering and a call for continued 20 percent reductions in water use by all district customers.

In a presentation to the NID Board of Directors, Water Operations Manager Chip Close recommended a package of conservation measures designed to meet requirements adopted Mar. 17 by the State Water Board and to ensure that NID has adequate carryover water storage going into next year in case the drought continues into a fifth year.

Urban Water Use

Drought measures in effect for users of piped, treated water include:

- Outdoor watering no more than three days per week, with no watering during the heat of the day (10 a.m. to 6 p.m.).
- No watering until 48 hours after a rain.
- No drinking water service in restaurants unless requested.
- Hotel and motel guest option of not having towels and linens changed daily.
- No water use that creates unnecessary runoff.
- Use of shutoff nozzle on hoses.
- No washing down of sidewalks
- Fountains must recycle water

NID and other water purveyors are being required to provide the State Water Board with monthly reports on water use, conservation compliance and enforcement efforts.

Irrigation Water Use

Drought measures in effect for users of canal water include:

- Voluntary reductions of 20 percent or more with mandatory reductions possible later in the year if conservation goals are not being met.
- New and increased irrigation water sales are limited to the smallest amount of water necessary for the customer's beneficial use.
- All customers are encouraged to use efficient irrigation practices.

- The irrigation season, which normally runs Apr. 15-Oct. 14, could be shortened this year depending on water availability.

In a water supply update, Water Resources Superintendent Sue Sindt said this year's water outlook is slightly worse than last year. She said the mountain snowpack is only about 6 percent of average water content for this time of year and that seasonal runoff is anticipated to be only 20-25 percent of average.

Officials credited district customers with reducing water use by an overall 16.4 percent during the 2014 drought and said an equal level or more will be needed to get through this year.

Close said that continued conservation, tight measurement and controls on the canal system, and the purchase of an available 20,000-25,000 acre-feet of additional water from the Pacific Gas and Electric Company will help meet the district's water supply needs for this year and next.

For drought information and helpful water efficiency advice, please see NID's website at www.nidwater.com. Water waste may be reported through an online form or by telephone, (530) 271-6799.

Filed under:

[Press Releases](#) by NID Administrator

NID: Snowpack at 4% of Average, Lowest Water Content in 94 Years

April 3, 2015



This April 1 aerial photo shows little snow on NID mountain watershed. Pictured is the Canyon Creek watershed looking downstream from French Reservoir to Faucherie, Sawmill and Bowman reservoirs in the distance.

Contact:
Chip Close
(530) 273-6185
or: Dave Carter
(530) 265-NEWS

FOR IMMEDIATE RELEASE:
(with photo)

NID: Snowpack at 4% of Average, Lowest Water Content in 94 Years

GRASS VALLEY – In snow surveys taken Wednesday (Apr. 1), the Nevada Irrigation District measured 4 percent of average water content in the mountain snowpack that supplies the NID water system.

“This is the lowest April 1 snowpack in our 94 years of records,” said NID Water Resources Superintendent Sue Sindt. “Needless to say, it is not a record that we are very excited about.”

NID snow surveyors found an average water content of 1.5 inches on five mountain snow courses, which compares to the April 1 average of 33.7 inches. Two of the courses had no snow; the deepest snow, 14.5 inches, was found at 7800 feet on Webber Peak, NID's highest course.

A year ago, the April 1 average water content was measured at 12.1 inches. Sindt said NID's previous low measurement was in 1934 with 9.1 inches.

"Fortunately, the district's water storage is slightly above average but that is not expected to last long with the limited amount of runoff from the snowpack," she said.

Gov. Brown on Wednesday called on California's urban water users to reduce water use by at least 25 percent, up from the 20 percent level in his 2014 drought declaration and the 20 percent level NID is currently seeking from customers.

The NID Board of Directors last month implemented Stage III drought contingency plans for treated water users and Stage II plans for irrigation water users. District officials are now evaluating what changes may be warranted to meet the new requirements.

This year's precipitation at Bowman Reservoir reached 40.62 inches, or 69 percent of average, as of Apr. 1. The last three months – January, February and March – produced only 10.46 inches, 31 percent of average.

The almost non-existent snowpack is attributed to a warmer than usual weather pattern that has brought more rain than snow.

A member of the California Cooperative Snow Survey, NID conducts four official snow surveys each year, in February, March, April and May. The April 1 snow survey is generally regarded as the best measure of water supplies for the coming year. Results of the snow surveys are used to predict water availability locally and statewide.

-30-

Filed under:

[NID Drought News / Updates](#), [Press Releases](#) by NID Administrator

NID Prepares for State Mandated Water Conservation Effort

April 9, 2015

Contact:

Rem Scherzinger
(530) 273-6185
or: Dave Carter
(530) 265-NEWS

FOR IMMEDIATE RELEASE:

More Water Use Reductions Expected

NID Prepares for State Mandated Water Conservation Effort

GRASS VALLEY – In response to Gov. Brown’s Apr. 1 call for statewide mandatory urban water use reductions, the Nevada Irrigation District is planning to adjust its existing water conservation efforts to comply as necessary.

In his drought emergency announcement, the governor directed the State Water Resources Control Board to implement mandatory water reductions in cities and towns across California. He estimated a 25 percent reduction would save 1.5 million acre-feet of water over the coming nine months.

In a report to the NID Board of Directors on Wednesday (Apr. 8), NID General Manager Rem Scherzinger said NID and its customers may be expected to conserve even more. He said the State Water Board looked at water use patterns throughout the state and may call on some areas, including NID, to reduce water use by 35 percent as a way to balance the overall goal with other areas that already use less water.

Scherzinger said the district is working with the State Board to find a solution that is more equitable for the district and its customers.

He said the district is also working toward compliance with other proposed requirements, particularly a call for local agencies to adjust their rate schedules to implement conservation pricing, which is seen as an effective way to realize water use reductions.

The governor’s declaration applies to nearly 20,000 NID customers who use piped, treated water. It does not apply to approximately 5,000 agricultural customers who use NID irrigation water, although all customers are urged to reduce usage as much as possible.

Since early 2014, NID has been urging customers to reduce water use by 20 percent. Scherzinger said NID customers responded very well to last year’s drought condition, reducing water use by 16.4 percent from 2013 levels, and that continued conservation is needed until the drought ends.

The greater Sacramento region, including Nevada and Placer counties, has consistently led the state in water use reductions over the past year.

This week’s welcome storms produced about a foot of snow at NID’s Bowman Reservoir and will provide a slight boost in runoff this spring, but will have little impact when it comes to ending the four-year drought, the general manager said.

The next regular meeting of the NID Board of Directors will be held at 9 a.m. on Wednesday, Apr. 22, at the NID Business Center in Grass Valley. NID board meetings are open to the public.

-30-

Filed under:

[NID Drought News / Updates](#), [Press Releases](#) by NID Administrator

Community Drought Briefing, NID Hosts Forum on This Year's Water Issues

May 6, 2015

Contact: Rem Scherzinger
(530) 273-6185
Or: Dave Carter
(530) 265-NEWS

FOR IMMEDIATE RELEASE:

Community Drought Briefing
NID Hosts Forum on This Year's Water Issues

GRASS VALLEY – Water issues facing the community during this fourth year of drought will be explored during a special community meeting hosted by the Nevada Irrigation District.

The NID Community Drought Briefing will be held on Thursday, May 21, at 5:30 p.m. in the Grass Valley Veterans Memorial Building, 255 South Auburn Street, in Grass Valley.

Community and water industry leaders from around Nevada and Placer counties have been invited to attend the meeting, which is also open to the public.

“We are facing some very severe cutbacks under the drought rules adopted by the State Water Board,” said NID General Manager Rem Scherzinger. “The district and its customers are being ordered to reduce our urban water usage by 36 percent (from 2013 levels),” he said.

“How can we meet this year's challenges, remain prepared for next year and be better prepared for future droughts? We want to share information and hear from our community.”

NID officials will present the latest information on water storage, precipitation, drought contingency planning, the state's water right curtailments, conservation targets, and a look at long-range water storage options for the future. A question and answer session is planned.

-30-

Filed under:

[NID Drought News / Updates, Press Releases](#) by NID Administrator

NID Urges Customers to Reduce Water Use by 36%

May 13, 2015

Contact:

Rem Scherzinger

(530) 273-6185

or: Dave Carter

(530) 265-NEWS

FOR IMMEDIATE RELEASE:

NID Urges Customers to Reduce Water Use by 36%

GRASS VALLEY – To meet regulations handed down by the State Water Board, the Nevada Irrigation District is asking its over 44,000 urban water users in Nevada and Placer counties to reduce their water usage by 36 percent (from 2013 levels).

“Our customers did a really good job last year, saving 16 percent,” NID Water Operations Manager Chip Close said at Wednesday’s (May 13) meeting of the NID Board of Directors. “If we can conserve that much again this year, we’ll be close to the target.”

The Water Board’s strict emergency conservation measures, issued May 5, come as California endures a fourth year of drought. The measures include fines for water wasters and fines for water suppliers who do not meet conservation targets.

Close said NID is monitoring and reporting its water usage to the state and will focus on water conservation education as opposed to heavy handed fines. He said the District plans to step up its public outreach efforts to promote water conservation.

Although the 2014/15 precipitation season has brought 69 percent of average precipitation to NID mountain watershed, much of the precipitation fell early in the season, and fell as rain rather than snow. The May 1 snowpack was the lowest on record at just 5 percent of average.

“We rely on the snowpack,” said Close. “This has been a rain-driven year. Without the snowpack our water supply curve is trending down much earlier than usual.”

Meanwhile, the United States Drought Monitor has placed the entire Northern Sierra region in the exceptional drought category, the most serious category, which extends through much of the state.

NID’s 5,000 irrigation water customers are not facing the same State mandated restrictions as treated water users but are encouraged to reduce water usage as much as possible. Close said the district has received reduction commitments of nearly 3,000 acre-feet from irrigation water users already this year.

In an average year, NID carries over about 150,000 acre-feet of water for the next year. This year, with increased conservation and purchases of additional water from the Pacific Gas and Electric Company, NID is aiming for at least 111,000 acre-feet of carryover storage for 2016.

NID’s ability to store additional water in its reservoirs is also being affected by the Water Board’s May 1 curtailment order that prohibits post-1914 “junior” water right holders from diverting water from streams and rivers. NID holds numerous post-1914 water rights but also holds numerous pre-1914 “senior” rights, some of which are among the oldest in the state. Senior water right holders have been given notice that they, too, may face curtailment later in the year.

Local water users are encouraged to visit the NID website, www.nidwater.com, for information and helpful links on the drought and water conservation.

-30-

Filed under:

[NID Drought News / Updates](#), [Press Releases](#) by NID Administrator

NID Outlines Plans for Getting Through Drought

May 22, 2015



Contact: Rem Scherzinger

(530) 273-6185

Or: Dave Carter

(530) 265-NEWS

FOR IMMEDIATE RELEASE:

Community Forum

NID Outlines Plans for Getting Through Drought

GRASS VALLEY – In a community forum on Thursday (May 21), leaders of the Nevada Irrigation District outlined plans to ensure adequate supplies of water to district customers as the region endures a fourth year of drought.

More than 100 people attended the NID Community Drought Briefing at the Grass Valley Veterans Memorial Building. NID staff provided overviews of NID's background and role in the community, current water supply, state drought regulations and the need for water conservation.

Manager of Water Operations Chip Close said regulations imposed on May 5 by the State Water Board require NID and its customers to reduce residential water use by 36 percent from 2013 baseline levels. District customers saved 16.4 percent last year.

Close said the district has been operating its water systems very conservatively and that water storage is near average for this time of year. However, a record low snowpack is producing negligible runoff to replenish reservoirs as they are drawn down this summer.

Through conservation and purchases of additional water supplies from the Pacific Gas and Electric Company, NID is aiming to preserve a minimum 110,000 acre-feet of water storage at the end of this year. The district carries over 140,000 acre-feet in the average year.

General Manager Rem Scherzinger said costs to purchase additional water, combined with significant revenue losses to the district from reduced water sales, would have serious financial impacts on the district. As a result, district officials are considering a conservation water rate that could be implemented later this year.

The briefing also included a discussion by NID legal counsel Dustin Cooper, who provided an overview of NID's water rights and how they are being impacted by the state's drought regulations.

NID Water Efficiency Coordinator Aurora Tipton spoke of water conservation options and methods available to customers and said the district is preparing additional materials to help customers measure their levels of conservation.

In a question and answer session following the hour-long presentation, Scherzinger was asked to compare this year to the near-record drought of 1977 that brought the need for 50 percent use reductions. "We've been working this very carefully and from all angles over the past four years," he said. "We have more water in storage, our water systems are more efficient and we know more about water conservation. We are much better prepared than we were in 1977."

A resolution adopting a water conservation plan for the coming year is expected to be considered at Wednesday's (May 27) meeting of the NID Board of Directors.

The NID website contains valuable tips and links on efficient water use. See the Conservation tab at www.nidwater.com.

-30-

Filed under:

[Press Releases](#) by NID Administrator

NID Adopts Water Conservation Regulation

May 28, 2015

Contact:

Rem Scherzinger
(530) 273-6185
or: Dave Carter
(530) 265-NEWS

FOR IMMEDIATE RELEASE:
District Seeks 36% Reduction in Use

NID Adopts Water Conservation Regulation

GRASS VALLEY – Directors of the Nevada Irrigation District on Wednesday (May 27) adopted a local water conservation regulation that is designed to meet statewide requirements handed down by Gov. Brown and the State Water Board.

NID Water Operations Manager Chip Close said the regulation calls upon NID’s residential water users to reduce usage by 36 percent from 2013 baseline levels. He said the district is seeking to reduce water use among all water users and will make every effort to help customers achieve the goal.

The reductions are necessary after Gov. Brown earlier this year extended his initial 2014 drought emergency into a second year and called for 25 percent reductions by residential water users. The State Water Board’s subsequent emergency regulations established differing conservation levels for different parts of the state in order to achieve the overall 25 percent level.

NID, with a warmer, inland climate, larger lot sizes, and high seasonal water use, was mandated to reduce consumption by 36 percent. District officials noted that customers reduced usage by 16.4 percent last year and encouraged increased conservation this year.

Close said it will be difficult for the District’s residential customers to cut use by 36 percent but the district continues to encourage customers to reach that goal. The district may also rely on reduced water use by irrigation water customers to help meet the target.

He said irrigation water customers have already committed to one-year reductions of nearly 3000 acre-feet of water, which is roughly a third of the annual usage of the district’s 44,700 residential users in Nevada and Placer counties.

Members of the NID Board voiced support for the district plan, saying the overall state plan does not recognize NID’s water system, operations and combination of residential and agricultural water uses.

“A different approach is needed for our area and I think we’re taking a very rational approach,” said Director Nancy Weber. “This is an entirely appropriate plan for the district,” said Director Nick Wilcox.

The NID regulation includes specific water use reduction methods, particularly those used in outdoor watering, where some of the greatest savings can be achieved. Prohibited use of potable water include:

- outdoor residential watering of more than two days per week.
- outdoor watering that causes runoff
- washing down of driveways and sidewalks

The regulation includes several other water saving measures. These and many more helpful hints on water conservation may be found under the Conservation/Drought tab at www.nidwater.com. Water waste may be reported via the NID website or by calling NID's Water Waste Hotline at (530) 271-6799. The six-page Water Conservation Regulation (Resolution 2015-15) will also be posted on the NID website.

The next regular meeting of the NID Board of Directors will be held at 9 a.m. on Wednesday, June 10, at the NID Business Center in Grass Valley. NID board meetings are open to the public.

-30-

Filed under:

[Press Releases](#) by NID Administrator

NID Reports 36% Water Conservation

July 9, 2015

Contact:

Rem Scherzinger
(530) 273-6185
or: Dave Carter
(530) 265-NEWS

FOR IMMEDIATE RELEASE:

NID Reports 36% Water Conservation

GRASS VALLEY – In response to serious drought conditions, the Nevada Irrigation District customers achieved a 36 percent reduction in potable water usage in June (compared to June 2013), reaching the mandates issued by Gov. Brown and the State Water Board.

“We are extraordinarily proud of our community,” NID General Manager Rem Scherzinger said at Wednesday’s (July 8) meeting of the NID Board of Directors.

Scherzinger encouraged water users to continue the high level of conservation until drought conditions ease. Mandatory and voluntary water conservation measures and helpful water-saving advice may be found under the Conservation/Drought tab at www.nidwater.com.

In other business, NID directors:

- held a public hearing and review of the district plan to encase a 1900-foot stretch of the Newtown Canal in pipeline. Officials said the canal section, located west of Nevada City, is in poor condition, running at capacity, and must be improved to ensure reliability of water supplies to Lake Wildwood and Penn Valley. The public hearing was held to offer an additional opportunity for comment on the project’s recently completed draft environmental impact report. Eight written comments were received and will be addressed in a final EIR which will now be prepared.

The next regular meeting of the NID Board of Directors will be held at 9 a.m. on July 22 at the NID Business Center in Grass Valley. NID board meetings are open to the public.

-30-

Filed under:

NID Reports 38% August Conservation Rate

September 10, 2015

Contact:

Rem Scherzinger
(530) 273-6185
or: Dave Carter
(530) 265-NEWS

FOR IMMEDIATE RELEASE:

NID Reports 38% August Conservation Rate

GRASS VALLEY – The Nevada Irrigation District and its water users in Nevada and Placer counties are taking the California drought seriously and saving more water than many areas of the state, it was reported at Wednesday's (Sept. 9) meeting of the NID Board of Directors.

NID General Manager Rem Scherzinger said that in August customers achieved a 38 percent conservation rate (from 2013 base levels) for the district's domestic water customers. This follows back to back 36 percent reductions in June and July.

In addition, NID operational adjustments and customer use reductions this year have reduced the use of irrigation water from the district's canal system by 14,122 acre-feet of water from 2013 levels, Scherzinger reported. This amount of water would supply NID's domestic users for about a year and a half.

"Overall, we're doing very well," he said. "Our customers realize that California is in a serious drought and everyone is pitching in to help."

NID reservoir storage remains at near average levels. As of Sept. 3, total storage was at 155,798 acre-feet, which is 84 percent of average for the date and 59 percent of capacity.

Scherzinger said reservoir levels at Jackson Meadows and Scotts Flat are below average for this time of year, with other reservoirs closer to average levels for this time of year. Scotts Flat is about to pass the 40 percent of capacity mark which is ahead of schedule, he noted.

The district is now projecting it will end the 2015 irrigation season with more than 110,000 acre-feet of carryover water storage for next year. This equals about 45 percent of the district's water storage capacity.

In other business, NID directors:

- awarded a \$152,482 contract to Simpson & Simpson, Inc. of Newcastle for final trench repaving work following the district's replacement of 7400 feet of water main lines and service lines in Cascade Shores east of Nevada City. The firm's bid was the lowest among three submitted to the district.
- reviewed land acquisition options for five federal Bureau of Land Management (BLM) parcels in the Centennial Reservoir project area along the Bear River between Rollins and Combie reservoirs. The parcels, whether owned by NID or the BLM, would remain in public ownership and be used to benefit the public. No action was taken.

The next regular meeting of the NID Board of Directors will be held at 9 a.m. on Sept. 23 at the NID Business Center in Grass Valley. NID board meetings are open to the public.

-30-

NID: Please Continue to Conserve Water

October 15, 2015

Contact:

Rem Scherzinger
(530) 273-6185
or: Dave Carter
(530) 265-NEWS

FOR IMMEDIATE RELEASE:

NID: Please Continue to Conserve Water

GRASS VALLEY – As dry summer weather stretches into fall, the Nevada Irrigation District is urging customers to continue water conservation efforts in face of a four-year drought.

NID General Manager Rem Scherzinger reported at Wednesday's (Oct. 14) meeting of the NID Board of Directors that conservation by domestic water users slipped to 18.5 percent in September (measured against 2013 usage levels). District customers achieved 36 percent conservation in June and July and 38 percent in August.

NID customers are being asked to reduce water usage by 36 percent under an executive order issued in April by Gov. Brown. Customers did an excellent job reducing outdoor water use during the summer months; however, as winter approaches conservation must be shifted from outdoor to indoor water savings.

With NID's six-month irrigation season ending Wednesday (Oct. 14), Scherzinger said canal flows are being reduced and remaining water is being held in storage. As of Oct. 7, NID reservoirs held 135,241 acre-feet of water, which is 86 percent of average for the date and 51 percent of capacity.

For more information on the drought and other NID activities, see the fall issue of the district's quarterly newsletter, NID WaterWays, at www.nidwater.com. The website also features a section on water efficiency and conservation.

-30-

Filed under:

[Press Releases](#) by NID Administrator

**NEVADA IRRIGATION DISTRICT**1036 W MAIN STREET
GRASS VALLEY, CA 95945-5424
Billing Office: (530) 273-6185**ACCOUNT STATEMENT**

ACCOUNT NUMBER 16207-00		BILLING PERIOD FROM TO 05/12/15 07/21/15	
CYCLE 228 (0)		APN N22-180-35-000	
BILL ISSUE DATE 07/21/2015	DUE DATE 08/04/15	AMOUNT DUE \$0.00	
SERVICE NAME AND ADDRESS			

93346AA21-Y-1
4591 Y SP 0.416000TERMS OF PAYMENT ON REVERSE SIDE

CONSUMPTION COMPARISON	METER SIZE	METER READINGS		HCF CONSUMED	TOTAL GALLONS CONSUMED	AVERAGE GALLONS USED PER DAY
		PREVIOUS	PRESENT			
USAGE / DAYS CURRENT 0 / 71	3/4 IN MTR	946	946	0	0	0

IMPORTANT MESSAGE

****Important Drought Information**** NID is targeting a 36% reduction in water usage as compared to the same time in 2013 and we are asking all customers to conserve. Mandatory outdoor water use restrictions are in place and include: - Limit watering to 2 days or less per week - No outdoor watering in the heat of the day - No watering that causes excess runoff For more information visit our website <http://nidwater.com/drought-information>

SERVICE DESCRIPTION**AMOUNT**

PREVIOUS BALANCE	\$126.96
PAYMENT 06/18/15	-\$189.50
BALANCE FORWARD	-\$62.54
3/4 IN MTR NON COM-IN	\$62.54
TOTAL AMOUNT DUE	\$ 0.00

PLEASE BRING THE ENTIRE BILL IF PAYING IN PERSON OR IF BY MAIL RETURN THE BOTTOM PORTION ONLY

**NEVADA IRRIGATION DISTRICT**1036 W MAIN STREET
GRASS VALLEY, CA 95945-5424
Billing Office: (530) 273-6185Please return this portion with your payment. Make your check payable to:
NEVADA IRRIGATION DISTRICT

ACCOUNT NUMBER 16207-00	AMOUNT DUE \$0.00
DUE DATE 08/04/15	AMOUNT ENCLOSED \$

TO ENSURE PROPER CREDIT TO YOUR ACCOUNT PLEASE
NOTE ACCOUNT NUMBER ON YOUR CHECK AND REMIT
PAYMENT TO:NEVADA IRRIGATION DISTRICT
1036 W MAIN STREET
GRASS VALLEY CA 95945-5424TERMS OF PAYMENT ON REVERSE SIDE



NID
NEVADA IRRIGATION DISTRICT

Waterways

A NEWSLETTER TO THE CUSTOMERS OF THE NEVADA IRRIGATION DISTRICT

NEW RESERVOIR PROGRESS

...STORY BELOW

**HOW TO SAVE WATER
THIS FALL.... PAGE 4**

**WATER
FOR SOUTH
NEVADA
COUNTY** →



... PAGE 3

Volume 36 • Number 3 • Fall 2015

High Hopes for a Wet Winter

As summer turns to fall in a region beset by four years of drought, there are high hopes for a wet 2015/16 rainfall season, or at least a return to more normal conditions.

While the odds favor a wetter winter, NID is planning for whatever Mother Nature may deliver. By Sept. 30, district water storage was measured at 138,500 acre-feet, which is 52 percent of capacity but 86 percent of average for the date.

The district was able to maintain adequate storage despite a 2014/15 precipitation year that produced a snowpack just 5 percent of average. Last winter's average daily minimum temperature in the Sierra Nevada was 32.1 degrees, the first time it was above freezing in at least 120 years.

While there are high hopes for an El Niño wet winter, a fifth year of drought is certainly possible. California has had two six-year droughts in the past 90 years, from 1929-34 and 1987-92.

Seasonal Tips for Saving Water

Page 4

How Dry I Am.... Scotts Flat



DROUGHT: By Oct. 7, Scotts Flat Reservoir had dropped to 18,300 acre-feet of water, about 37 percent of capacity. The last time Scotts Flat approached this low level was in 1988 when it dipped to 20,800 acre-feet.

NID Moving Forward on New Reservoir Project

With construction of the planned Centennial Reservoir, NID will be positioned to reduce over-reliance on mountain snowpack and to store more water at mid-elevation levels in the Sierra foothills.

District leaders say NID's current water system relies too much on the water storage contained in the annual snowpack. More storage at the lower elevations will capture more runoff from rain events, water that now flows through the district and is lost to local water users.

Additional water storage capacity will allow the district to improve and expand water service within NID's Nevada and Placer county service areas. Water supplies for local agriculture could be strengthened.

(Please See New Reservoir, Page 2)

General Manager's Report

By Rem Scherzinger



NID Customers Stand Up to the Drought

What will the 2015/16 rainfall year bring to Northern California? Are we looking at a wet El Niño year? Another warm winter that brings more rain than snow to our mountain watershed? Or worse, a fifth year of drought?

Whatever winter delivers, NID stands prepared. Due to outstanding water conservation efforts this year by NID customers, along with the district's own tightened operations, we have maintained adequate year-to-year carryover water storage for next year. What this means is that we are well positioned to meet basic needs for water service in 2016.

This fall, as we near the mid-October end of the 2015 irrigation season, NID reservoirs are holding about 130,000 acre-feet of water, which is more than the 110,000 acre-foot minimum level we established early this year.

Readers will remember Gov. Brown's April 1, 2015 executive order, which called for a 25 percent reduction in statewide urban water use. To reach the statewide goal, the State Water Board mandated different levels for different water suppliers. In NID's case, we were ordered to reduce usage by 36 percent (measured against 2013 baseline levels).

38% Conservation Rate in August

NID customers have done better than that, and we applaud you! We reached the 36 percent conservation mark in June and July and achieved 38 percent in August. Our irrigation water deliveries were down by 14,122 acre-feet as of Sept. 9. This savings alone could supply our urban water customers for a year.

Looked at in another way, in January through August of this year, we have reduced treated water use by 29 percent, or 699 million gallons!

These savings have not come without sacrifice. Farmers and ranchers are dealing with reduced production, brown lawns are apparent throughout our service areas and, of course, we all have endured the high fire dangers exacerbated by the continuing drought.

On behalf of your elected NID Board of Directors and district staff, I thank all NID water users for your awareness and support as we make our way through one of the driest periods in state history. We are hopeful this winter brings the change we all have been waiting for

www.nidwater.com

A Look Back...

NID's First Office Building



NID's first office (pictured in 1936) was built in 1928 at 144 South Auburn Street in Grass Valley, now the site of a municipal parking lot. The building was gutted in a late night fire on Sunday, Sept. 6, 1964 but NID was able to salvage most records. Rather than rebuild, district officials chose to construct a new office building at NID's 18-acre maintenance and construction property on West Main Street. At the time, Grass Valley merchants were pushing for more downtown parking and in December 1964 the Grass Valley City Council purchased the fire site from NID for \$92,625. In 2016, the current NID Business Center marks 50 years at the present location. The building has been expanded twice to keep pace with district growth; once in 1989 and again in 1998.

New Reservoir - *Cont'd From P. 1*

The Centennial Reservoir and Power Supply Project includes a 110,000 acre-foot reservoir on the Bear River between Rollins and Combie reservoirs, two hydroelectric power stations and low impact public recreation.

NID began planning the project in August 2014 in filings with the State Water Resources Control Board. Steady progress has included preliminary geotechnical investigations, environmental work has begun, and preliminary design is scheduled in 2016. Construction is planned to begin in 2021 with completion in 2023.

The project is estimated at \$200-\$300 million and would be NID's most significant advancement since the Yuba-Bear Hydroelectric Project doubled district water storage 50 years ago.

Winter Storm Readiness

NID customers are reminded to make sure that all exposed pipes and faucets are protected against freezing temperatures. Frozen pipes can lead to loss of water, property damage and expensive repairs. Inexpensive pipe insulation is available from local building supply outlets.

If predictions of a strong El Niño condition prove true, we could see some heavy rainstorms this winter. To be prepared, check and clean your rain gutters and make sure drainages and canal spillways are clear.

Seasonal Tips

Water Conservation: Autumn

As cooler weather sets in, it is still important to save water and make conservation an everyday habit.

The California *Save Our Water* campaign encourages water users to "Fit It For Good" when it comes to repairing leaks, going efficient with new toilets and fixtures, and rethinking outdoor water use.

Here are a few reminders for fall and winter:

- **Adjust your sprinkler schedule.** In cooler weather, lawns and plants don't need as much water. When it's raining, they don't need watering at all. You can invest in a weather-based sprinkler system and never again have to worry about irrigation schedules.

- **Get a jump on spring plantings.** Many plants can be set in the fall. They will require less water and will look better in spring.

- **Check for leaks.** Find and fix leaks now. One way to find leaks is to read your water meter, refrain from any water use for two hours, and then read the meter again. If the reading has changed you probably have a leak.

- **Install low-flow showerheads.**

- **As you wait for hot water,** collect the running water to water your plants. Better yet, install a circulating hot water system.

- **Hold a household meeting** and remind everyone to keep showers to five minutes or less, run only full loads in the washer and dishwasher, and to not use the toilet as a wastebasket.



DWR Offering Conservation Rebates

The California Department of Water Resources (DWR) has a rebate program that provides rebates of up to a \$2000 for turf or grass replacement and up to \$100 for purchase and installation of one qualified high-efficiency toilet. For information, see:

<http://saveourwaterrebates.com/>

How to Contact Your Elected Directors

DIVISION I - Nevada City Area
Nancy Weber, (530) 265-0424
Board Vice President, 2015

DIVISION II - Grass Valley-Chicago Park
John Drew, (530) 272-5257

DIVISION III - Lake of the Pines-Alta Sierra
Scott Miller, M.D., (530) 268-8778
Board President, 2015

DIVISION IV - Lincoln-North Auburn
William Morebeck, (916) 645-8650

DIVISION V - Penn Valley-Lake Wildwood
Nick Wilcox, (530) 432-2171



Newsletter produced with
30 percent post-consumer
waste recycled paper and
vegetable-based inks



Working Together for Wolf Creek

The Wolf Creek Community Alliance (WCCA), a citizen group dedicated to protecting and restoring Wolf Creek, now has a water quality laboratory at NID. The small building is being leased to the Alliance for \$1 per month. Pictured in front of the structure are WCCA President Jonathan Keehn and NID Asst. General Manager Tim Crough.

NID NEWS BRIEFS

NEW FINANCE MANAGER. Marvin V. Davis joined NID Sept. 8 as the district's Finance Manager, overseeing a combined annual budget of \$68.5 million and a team of 21 employees in Accounting, Customer Service, Information Technology and Purchasing. Davis is a U.S. Air Force veteran who holds an MBA from CSU Fresno and comes to NID from the City of Lincoln, where he served as accounting manager.



Marvin Davis

GOOD AUDIT. The NID Board of Directors on July 22 accepted a 2014 audit of the district by the certified public accounting firm of Richardson & Co. LLP, of Sacramento. The firm concluded that NID financial statements fairly present the district's financial position and that NID's records are kept in accordance with generally accepted accounting principles.

Drought Impacts NID's Bottom Line

With a largely commodity-based rate structure, NID revenues are directly related to the amount of water the district sells.

With ongoing conservation bringing reduced water sales, district leaders have studied the need for drought-related rate surcharges, but none are planned at this time. The 6 percent 2016 general rate increase as called for in the district's five-year financial plan is scheduled.

To cover drought-related financial impacts, the district has used reserve and hydroelectric funds and has reduced or postponed maintenance and construction work.

NID's QR Code
Scan this QR Code with
your smart phone for direct
access to the NID website.



<http://www.nidwater.com>

Pledge of Service



Employees gathered for a team photo at the annual NID "All Hands Meeting."

Water Conservation Tips: Winter

Even though we've seen good rain and snow, the drought is not over and water conservation remains important. Here are a few seasonal tips for saving water:

- Remember, mandatory restrictions are in place for treated water users. Outdoor watering during and within 48 hours after rain is prohibited.
- Consider turning off sprinklers until spring. At a minimum, reduce watering to one day per week. Let Mother Nature do the job!
- With freezing temperatures it's important to insulate pipes and prevent them from freezing. A broken pipe can be costly and a huge water waster!
- Shorten your shower by a minute or two and you'll save up to 150 gallons per month. Time your shower to keep it under five minutes. You'll save up to 1,000 gallons per month.
- When washing dishes by hand, don't let the water run. Fill a basin with wash water and rinse in the other.
- Toilet leaks can be silent. Be sure to test your toilets at least once a year. Stop by the NID Business Center and pick up free dye tablets to test your toilets.
- Consider replacing your older toilet with a high efficiency toilet. Visit www.saveourwaterrebates.com for information on how to qualify for up to a \$100 rebate when you replace an inefficient toilet with a new 1.28-gallon or less high efficiency toilet.



How to Contact Your Elected Directors

DIVISION I - Nevada City Area
Nancy Weber, (530) 265-0424
Board President, 2016

DIVISION II - Grass Valley-Chicago Park
John Drew, (530) 272-5257

DIVISION III - Lake of the Pines-Alta Sierra
Scott Miller, M.D., (530) 268-8778

DIVISION IV - Lincoln-North Auburn
William Morebeck, (916) 645-8650

DIVISION V - Penn Valley-Lake Wildwood
Nick Wilcox, (530) 432-2171
Board Vice President, 2016



Newsletter produced with
30 percent post-consumer
waste recycled paper and
vegetable-based inks



Water Supply

Continued From P. 1

"These are more normal conditions for us," Sindt said. "This year is shaping up to be much better than the last few years. At this time, the district is continuing to manage water supplies very conservatively and continuing to ask customers to conserve water."

Sindt said the wet weather pattern seen in mid-January was forecasted to continue through the month and perhaps into the spring months. Weather watchers continue to track the El Niño weather condition in the Pacific Ocean which can influence California rainfall.

More information on the coming year's water supply is expected following NID snow surveys on Feb. 1, Mar. 1 and Apr. 1. Snow survey information is used to predict water availability locally and statewide.

2016 Budget, Water Rate Update

NID's combined annual budget for 2016 is \$74.5 million. The combined budget includes a Water Division budget of \$55.2 million, Hydroelectric Division budget of \$16.9 million, and Recreation Division budget of \$2.3 million.

All customers will see a 6 percent increase in water rates this year. It is the third rate adjustment in the district's current financial plan. The plan, approved in 2014, is aimed at bringing water rates more in line with the district's costs of providing service. NID water rates remain among the most affordable in the region.

Water Conservation with Nevada County RCD

The Nevada County Resource Conservation District is scheduling several workshops this spring to assist landowners better manage their resources. Several sessions on water conservation are included.

In addition, NID will partner with the RCD in a "Mulch Madness" event this spring in which landowners may obtain free water-saving mulch for gardens.

For information on dates and schedules, call the RCD's Grass Valley office at (530) 272-3417 or see www.nrcrd.org.

NID's QR Code
Scan this QR Code with
your smart phone for direct
access to the NID website.



<http://www.nidwater.com>



NID

NEVADA IRRIGATION DISTRICT

Waterways

A NEWSLETTER TO THE CUSTOMERS OF THE NEVADA IRRIGATION DISTRICT

**NID Rebounding
From the Drought:
Conservation Still Needed**
...P. 1, P.2

**NID LEGENDS:
The Russian of
Texas Creek**
...P. 3



Volume 37 • Number 2 • Summer 2016

State Lifts Drought Restrictions

Water Conservation is Here to Stay

The State Water Resources Control Board in mid-June lifted the mandatory water conservation measures that have been in place to save water during California's historic drought.

NID thanks you, our customers, for doing a tremendous job in saving water during the drought. We appreciate all you did to reduce water use and meet mandatory water conservation requirements under the state's emergency regulation of a year ago.

Thanks to last winter's improved rain and snowfall in Northern California and strong conservation statewide, specific state-mandated actions are being replaced with locally determined measures designed to maintain our water-wise *(Please See Conservation, P. 2)*



Water Efficient Landscape



Members of the community are invited to stop by and visit the new water efficient landscape in front of the NID Business Center in Grass Valley where native and low water use plants are displayed and identified. Pictured are NID's Aurora Tipton with Adam Weiss and Greg Chapman of Weiss Landscaping. The landscape is open during normal business hours.

Water Project Aids Cascade Shores

The community of Cascade Shores at Scotts Flat Reservoir will be connected to NID's modern Elizabeth L. George Water Treatment Plant in a water project now in progress and scheduled for completion later this year.

The work includes more than three miles of 12-inch transmission line running from Banner Mountain. It is designed to improve water quality and reliability for NID's 400 customers in Cascade Shores. It includes fire hydrants and is sized for future expansion of the treated water system. The new connection will allow the district to abandon the old and undersized water treatment plant that dates to the original development of Cascade Shores. It will also reduce the small community's dependence on the upstream South Yuba Canal.



Jackson Meadows Reservoir, June 24, 2016

NID Water System Rebounds From Drought

After four years of drought, NID's water storage system has returned to near normal levels. As of July 11, the district's 10 reservoirs held 246,300 acre-feet of water, which is 114 percent of average for the date and 93 percent of capacity.

The generous 2015/16 rainfall year ended June 30, with 79.92 inches of precipitation (Bowman Reservoir, elev. 5,650 ft.). This equals 116 percent of the 130-year average of 69.12 inches.

Conservation Encouraged Continued From P. 1

habits and ensure we have adequate supplies for an additional three years of drought.

The bottom line is that while NID no longer has a specific state-mandated conservation standard, the district encourages everyone to continue using water efficiently. It's a way a life in California.

If the drought of the last four years has taught us anything, it's that water is a precious resource, wasting it is foolish and there are many relatively easy ways to conserve water. As we move away from state-mandated extraordinary conservation, certain wasteful practices remain prohibited, including watering hardscapes or irrigating within 48 hours of precipitation. We ask you to keep these and other water saving practices in place since the next dry year may be right around the corner.

Again, we thank you for your heroic efforts and congratulate you for becoming the efficient water community you are today. Please visit www.nidwater.com or www.saveourwater.com for water saving tips. Keep saving! It is the wise - and indeed the California - thing to do.

www.nidwater.com

www.centennialreservoir.org

Newtown Canal Upgrade Under Way This Summer



An upgrade to a critical section of the Newtown Canal near Newtown and Champion Mine roads west of Nevada City is in progress this summer, with completion expected later this year.

NID has placed high priority on the upgrade because the Newtown Canal is the primary source of water to NID's Lake Wildwood Water Treatment Plant, which supplies customers in Lake Wildwood and Penn Valley.

The Newtown Canal project is designed to improve water quality and remove a significant bottleneck in the canal. About 1900 feet of the canal is being realigned through a pipe along a roadside easement.

The canal realignment is being completed by Hansen Brothers Enterprises, Inc. of Grass Valley under a \$1.3 million contract awarded May 25 by the NID Board of Directors.

Timing of the canal realignment has been coordinated with the County of Nevada, which is planning road improvements in the area. This will allow NID to save an estimated \$65,000 in pavement overlay costs.

NID Pursues Fish Passage On Auburn Ravine Creek

NID Directors on June 8 authorized engineering studies of two alternatives for modifications to the Hemphill Canal diversion point on Auburn Ravine Creek between Auburn and Lincoln. Fish movement is currently limited by a three-foot-tall seasonal diversion NID installs on the creek each spring to deliver water to customers in the greater Lincoln area.

The two alternatives identified for further study are a streamside sump structure and a costlier stream bank well system. Both options would eliminate the need for the seasonal diversion structure.

The engineering analyses will become part of NID's environmental studies and project permitting processes, which could take four or more years. Engineering Manager Gary King said NID has applied for grant funding for the project but has received no commitments.

Community Support

The board's decision was applauded by local community groups, including Friends of Auburn Ravine and Auburn Ravine Preservation Committee, who are working toward improving fish passage on the creek.

The Hemphill project could improve fish passage to an additional six miles of Auburn Ravine. It would be NID's second significant contribution to fish migration in Auburn Ravine. The district's \$1.2 million fish ladder below Highway 65 in Lincoln, completed in 2011, earned finalist honors in the statewide environmental awards program of the Association of California Water Agencies (ACWA).



NID

NEVADA IRRIGATION DISTRICT

Waterways

A NEWSLETTER TO THE CUSTOMERS OF THE NEVADA IRRIGATION DISTRICT

**State Mandate for
33% Water Use Cut
Remains in Effect**

**Wettest, Driest Years on
Record, Recent
Precipitation Data
...Page 3**

Volume 37 • Number 1 • Spring 2016

Water Supply

NID Reservoirs Fill But California Drought is Still On

The winter of 2015/16 has been a very good one for Northern California but not so good for the southern part of the state. Though wetter than average conditions prevailed in our region, the year has not been the “drought buster” that some hoped for.

Despite NID’s above average precipitation and system of full reservoirs, mandatory water use restrictions imposed by the State Water Resources Control Board remain in place. This means that customers who use treated, piped water must reduce usage by at least 33 percent, as measured against 2013 levels.

NID irrigation water users are not under the same mandates. The NID Board of Directors on Mar. 23 rescinded the district’s year-old drought emergency declaration and declared that normal irrigation water deliveries would be available this year.

The State Board hosted a hearing on April 20 to consider easing state restrictions in some regions but any changes were not expected until May. Meanwhile, NID treated water users



Irrigation Season Opens

Joe Gobert Jr. adjusts a water gate that releases water from Lower Scotts Flat Reservoir into the DS Canal. The NID irrigation season runs each year from on or about Apr. 15 through Oct. 14. Gobert is a water distribution operator in the Nevada City area.

are encouraged to keep up the strong conservation efforts of the past few years.

NID Water Supply

By April 24, seasonal precipitation at Bowman Reservoir had reached 77.02 inches, or 122 percent of average for the date. The amount had already exceeded the average

annual level of 69.02 inches (precipitation is measured annually July 1-June 30).

A good snowpack is expected to bolster this year’s water storage.

NID’s April 1 snow survey found an average 33.9 inches of water content in the mountain snowpack, which is 102 percent of average. By comparison
(Please See Water Supply, P.3)

General Manager's Report



By Rem Scherzinger

It's a Long Road Back to Normal

It's been a wet winter here on the western slope, fairly normal by our standards. We've had ample rain and the NID water system is filling to the brim.

But wait, the drought is not over. Our friends in Sacramento keep reminding us that the rest of California - especially areas to the south - remain dry and will be short of water again this year.

After four years of drought, it's not an easy or balanced recovery and, unfortunately, it appears that NID customers could be called upon to conserve serious amounts of water again this year.

We commend all of our water users for their heroic support, awareness and meaningful water conservation efforts through recent years. These efforts have allowed the district to achieve or nearly achieve the ham-fisted conservation requirements handed down by state water regulators.

But now, as our reservoirs spill and our rivers cascade toward the valley, it is difficult for NID to remain in a position where we have to enforce these locally blind water conservation standards upon our community.

33% Conservation Mandate

At this writing, NID's more than 20,000 treated water customers are expected to reduce water usage by 33 percent from 2013 levels. At the same time, our irrigation water customers, who use about 90 percent of the water supplied by the district, face no mandatory cutbacks.

We are pleased to make normal deliveries this year to our irrigation water customers; we know many of you have faced tough times and made tough economic choices due to the drought. We can only hope that reasonable levels of water use for our treated water users will soon resume.

The Governor's drought emergency declaration remains in effect until Oct. 16 and the State Water Resources Control Board met Apr. 20 to further consider what conservation levels may be appropriate for different regions. NID has joined with other north state and mountain counties water entities in making our case for less stringent requirements.

Water conservation is here to stay and we are doing our part to operate our water systems as efficiently as we can and in offering help and assistance to our customers in their efforts to save water.

We hope to be able to announce soon that more reasonable and attainable conservation efforts will return to the customers of the Nevada Irrigation District.

Thank you once again for helping all of us through the difficult four-year drought.

AA+ Bond Rating

District Issues Bonds for Water System Upgrades

A solid financial position, diversified operations and a Standard & Poor's AA+ bond rating have allowed NID to complete a \$24.7 million bond issue that will be used primarily to modernize the Combie Phase I Canal and Bear River Siphon.

The bonds carry a favorable true interest cost (TIC) of 2.15 percent and will be repaid from district revenues over a 15-year period.

The bond issue was approved Mar. 23 by the NID Board of Directors and secondly by the NID board acting as directors of the NID Joint Powers Authority. The district has successfully completed previous bond issues through the JPA.

The district retained a bond counsel and financial adviser who worked with the district's financial team to plan the transaction. In presentations to the board, bond counsel Douglas S. Brown of Stradling, Yocca, Carlson and Rauth of Sacramento, and financial adviser Robert Porr of the Irvine-based Fieldman, Rolapp & Associates, both cited the district's strong financial position and good credit standing.

Most of the bond funding will be budgeted toward an estimated \$20 million upgrade of the Combie Phase I Canal system, NID's primary supply link to customers in Placer County, carrying about 60 percent of the water supplied by NID. The aging canal carries water through the steep Bear River canyon and the siphon carries the water across the river into Placer County. The district plans to allocate another \$3.2 million to planning and environmental work on the Centennial Reservoir project and \$1.3 million for environmental mitigation land acquisitions.

Top 5 Uses

How NID Water Is Used

NID water supports the agricultural production of more than 5,000 irrigation water users across Nevada, Placer and Yuba counties. As part of their irrigation water purchases, these customers submit reports on what they're growing with their water. Here are the leading water uses as summarized in NID's 2015 crop report:

Crop/Acreage

Irrigated Pasture

18,108

Family Garden, Orchard

5814

Fruit (except grapes)

1008

Forage

884

Grapes

612



Water Supply

Continued From P. 1

ison, a year ago just 1.52 inches of water content was found in what became the lowest snow year on record.

Water storage has rebounded well from the four-year drought. NID's 10 reservoirs stood at 249,300 acre-feet as of Apr. 15, which is 94 percent of capacity and 129 percent of average for the date. Reservoir levels are expected to remain up, making this a good recovery year for hydroelectric power generation and public recreation.

Wettest Year on Record

1903/04

142.07 Inches

Rainfall Data: Wet, Dry, Recent Totals



NID Mountain Watershed

NID is a foremost source for local weather data, with precipitation records at Bowman Reservoir (elev. 5,650 ft.) dating back to 1872.

The wettest year on record? That was back in 1903/04 with 142.07 inches. The driest year? The second year of the mid-70s drought, 1976/77, produced just 30.80 inches.

Average annual precipitation at Bowman is 69.02 inches.

Precipitation at Bowman Reservoir Since 2000

Year	Inches
2000/01	41.57
2001/02	65/62
2002/03	75.74
2003/04	51.91
2004/05	73.94
2005/06	100.61
2006/07	48.74
2007/08	52.07
2008/09	67.88
2009/10	65.78
2010/11	123.67
2011/12	58.18
2012/13	57.94
2013/14	47.08
2014/15	48.52
2015/16	77.02 (4-24-16)

Annual Avg: 69.02
(measured July 1-June 30)

Lead Not an Issue in NID Water

The January 2016 public health emergency declared in Flint, Michigan has focused public attention on dangers of lead contamination in public drinking water supplies. Lead was found to be leaching from aging pipes in the water delivery system.

Lead has not been an issue in NID's treated water system. The district has conducted lead testing for many years, including at-the-tap lead and copper testing since 1992. The tests are conducted under the Lead and Copper Rule adopted by the EPA in 1991 as part of the Safe Drinking Water Act.

Lead is generally not found in NID source waters. It can be found in air pollution (this is why leaded gasoline has been banned), old paint and contaminated soils.

NID water quality specialists say that old plumbing systems in private homes could be a potential source of lead, through corrosion in old pipes, solder and faucets.

To learn more, see your annual NID Water Quality Report. The reports summarize testing results of the quality of water supplied to customers in the previous calendar year. See your report at www.nidwater.com.

The EPA provides a good overview at www.epa.gov/your-drinking-water/basic-information-about-lead-drinking-water.

www.nidwater.com

www.centennialreservoir.org

NID NEWS BRIEFS

2016 Water Rates. District customers are reminded that a 6 percent water rate increase is in effect for all classes of water use. The adjustment is part of the district's 5-year plan to balance revenues with rising costs of doing business.

Two Veteran Employees Retire. NID recognizes the community service of two longtime employees who are retiring. **Kathy Anderson**, a buyer with NID's Purchasing Dept., retired Apr. 10 from a 26-year with the district. **Bill Winkle**, a Senior Water Distribution Operator with the Operations Dept., retires from a 27-year NID career on May 2.



Anderson Winkle

Water Wasters Hotline. If you notice water being wasted around your neighborhood or community, you might consider reporting it to the NID Water Wasters Hotline. Call (530) 271-6799.

Work Near a Canal or Pipeline? Are you planning a project, such as an outbuilding, bridge or culvert near a district facility? Please check with the district first to obtain an encroachment permit. This will ensure your rights to use your private property while protecting operation of the public water supply.

Strategic Plan Update. The NID Board of Directors on Apr. 13 approved a 2016-18 update of the NID Strategic Plan. The plan outlines the district's mission statement and lists specific goals and action items. It may be viewed under the Planning tab at: www.nidwater.com.

No Motors for a Day



Scotts Flat

Kayakers, sailors and paddleboarders turned out at Scotts Flat Reservoir Apr. 24 to enjoy NID's 9th Annual "No Motor Day." The Gold Country Yacht Club, Mountain Recreation and Boy Scout Troop 4 helped host the event, which promotes non-motorized recreation.

Comments Welcome on Raw Water Plan

NID's Raw Water Master Plan includes a draft capital improvement plan (CIP) that addresses capacity issues on canals and raw water facilities throughout the district.

Prior to adoption of the CIP, the district is conducting a programmatic environmental review of the plan. A Notice of Preparation (NOP) for an environmental impact report is scheduled to be issued this spring.

Customers wishing to review or comment on the process are invited to visit the NID website. The item will be posted at <http://midwater.com/planning/>

How to Contact Your Elected Directors

DIVISION I - Nevada City Area

Nancy Weber, (530) 265-0424

Board President, 2016

DIVISION II - Grass Valley-Chicago Park

John Drew, (530) 272-5257

DIVISION III - Lake of the Pines-Alta Sierra

Scott Miller, M.D., (530) 268-8778

DIVISION IV - Lincoln-North Auburn

William Morebeck, (916) 645-8650

DIVISION V - Penn Valley-Lake Wildwood

Nick Wilcox, (530) 432-2171

Board Vice President, 2016



<http://www.midwater.com>

NID's QR Code

Scan this QR Code with your smart phone for direct access to the NID website.

Water Efficiency

How to Know if You Are Overwatering

One of the easiest ways to save water is to make sure you are not overwatering your lawn and plants. Most of us water more than we need to, which not only wastes water but ends up drowning our plants. Watering for fewer days for the appropriate amount of time will give you healthier plants with less water use.

Here are some general guidelines on how to make sure that you are watering the correct amount:

1. Irrigation for lawn areas can be kept to three days in the summer with "run and soak" cycling of an irrigation valve/station.

For example, Program A for sunny lawn areas, can have three start times, three minutes with 30-60 minutes between each run time. Be aware that sun exposure and slope of the lawn area are factors to consider in calculating the amount of time the irrigation runs. Shaded lawn does not need as much water. Ensure irrigation water does not result in runoff.

2. Mature shrubs can usually be limited to watering two days a week in the summer. Be aware that sun exposure and slope of the landscape areas are factors to consider in calculating the run time. Check Sunset's Plant Finder to determine if your plants are high, medium, or low water use. Water in cycles (e.g. 5 minutes of run time with time in between to allow water to soak through to the plant's root zone). Run times will depend on the plant type. Watering with this technique encourages deep rooting by water percolating to depths of at least several inches into the soil for shrubs, deeper for trees. Ensure irrigation water does not result in runoff.

3. Once the root system is strong and deep enough, the plants will withstand more periods of no irrigation, particularly when day length is shortened and soil temperatures are cooler.

4. Annuals or water-loving plants can be efficiently irrigated with this method as long as they are rooted into the native soil. On new plantings, make sure the root ball is moist as well as the surrounding soil to encourage rooting beyond the original container size.

5. Apply 2-3 inches of mulch on any bare soil to keep soil temperatures cool.

Learn more at www.SaveOurWater.com.



NID Reports Improving Water Storage

January 14, 2016

January 13, 2016

Contact:

Rem Scherzinger

(530) 273-6185

or: Dave Carter

(530) 265-NEWS

FOR IMMEDIATE RELEASE:

GRASS VALLEY – After five years of drought, a return to more normal winter weather is improving the outlook for the coming year’s water supply, it was reported at Wednesday’s (Jan.13) meeting of the Nevada Irrigation District Board of Directors.

General Manager Rem Scherzinger said seasonal precipitation had reached 104 percent of average as of Jan. 7 with an outlook for continued wet weather. Precipitation at NID’s Bowman Reservoir (elev. 5650 ft.) was measured at 28.95 inches on Jan. 7.

Rainfall is measured each year July 1 through June 30.

A deepening snowpack also bodes well for local water storage. The Jan. 7 snowpack was estimated to hold 17 inches of water content. A year ago, there was virtually no snow in what turned out to be the lowest snow year on record. More information on this year’s snowpack is expected following NID’s Feb. 1 snow surveys.

Scherzinger said NID’s Jan. 7 water storage stood at 151,000 acre-feet, which is just short of the 159,600 acre-foot average for this time of year. NID storage bottomed out in late October at 132,200 acre-feet.

In other business, NID directors:

- Approved an update of the district’s 2012 Agricultural Water Management Plan, subject to minor changes. The state-mandated plan is designed to help agencies use best management and water efficiency practices in agricultural water delivery.
- revised the district’s formula for calculating the capacity fees paid by commercial and multi-unit residential developers who connect their properties to the public water system.

The next regularly scheduled meeting of the NID Board of Directors will be held at 9 a.m. on Jan. 13 at the NID Business Center, 1036 West Main St., in Grass Valley. NID board meetings are open to the public.

-30-

Filed under:

[NID Drought News / Updates, Press Releases](#) by NID Administrator

The 2nd Annual Mulch Magic Giveaway!

April 27, 2017

Contact:

Susan Holt

(530) 271-6735

The 2nd Annual Mulch Magic Giveaway!

Grass Valley – NID and the Nevada County Resource Conservation District (NCRCD) are highlighting the multiple benefits of using mulch for gardening and landscaping with the 2nd Annual Mulch Magic Giveaway. This event will provide approximately 160 cubic yards of shredded redwood bark to community residents, and is part of NID's continuing efforts to promote conscientious water use and conservation in our region.

The Mulch Magic Giveaway begins today, April 26, 2017, and will continue through June 30, 2017, or while supplies last. The community is invited to participate and may now begin picking up vouchers from the NID Business Office, located at 1036 West Main Street in Grass Valley, or the NCRCD office, located at 113 Presley Way, Suite 1 in Grass Valley. Each voucher entitles the holder to ½ cubic yard of mulch per residence, and is redeemable at Rare Earth Landscaping in Grass Valley, or Four Seasons Landscaping in Penn Valley. The mulch is provided in bulk and will require a truck for pickup.

Some of the benefits of using mulch include:

Sixty gallons of water saved per week, by adding 2 to 3 inches of mulch around trees and plants for each 1,000 square feet of irrigated landscape.

Mulch keeps soil moist and slows evaporation, allowing water to sink into the soil, which reduces the rate of watering needed for plants to thrive.

Mulch breaks down into the soil, providing nutrients for trees and plants.

Mulch protects plants by moderating soil temperature and suppressing weeds.

For more information on the Mulch Magic Giveaway, or on the benefits of using mulch, please contact: Kaycee Strong at 530-273-6185, ext. 244.

Water Conservation Update:

Thank you NID customers who drink and use treated water for their homes and businesses as well as growers who use untreated water on their crop. You continue to make conservation a way of life.

Since 2013, which started the worst drought in modern times, NID customers slashed their treated water use by nearly 22 percent. That's more than 2.6 billion gallons of water!

Irrigation water users conserved 16,804 acre-feet. This is an impressive amount considering an entire year of treated water use by District customers is only around 10,000 acre-feet. Conservation efforts include voluntary cutbacks and District re-operation of the raw water system to keep flows at a minimum.

Daily Use in Homes – we can do better

The State Water Resource Control Board recently released statistics of how much water residential customers use on a daily basis. Statewide, that average has continued to fall. Measured in terms of gallons per capita per day (R-GPCD), the latest statewide average is 110.5. The Sacramento region comes in at 173.

NID residents had a 254 R-GPCD for the same period. That means we need to keep vigilant in our conservation efforts!

Here's the NID R-GPCDs in September through recent years:

- Sept. 2013 - 232
- Sept. 2014 - 216
- Sept. 2015 - 184
- Sept. 2016 - 223
- Sept. 2017 - 254

By comparison, neighboring district R-GPCDs are as follows:

- Placer County Water District - 197
- El Dorado Irrigation District - 271
- Sacramento Suburban Water District - 147
- City of Roseville - 177

See the full September 2017 State Water Board conservation report/list [here](#).



NID Photo Contest 2017

The first employee photo contest was held at NID in 2017. Congratulations to these talented photographers:



FIRST PLACE - Rollins Lake at Greenhorn by Adrian Schneider



SECOND PLACE - Winter at Scotts Flat Lake by Gus Gramm



THIRD PLACE - Chicago Park Powerhouse by Ken Hart



FOURTH PLACE - Fixed Cone Valve at Jackson Meadows by Chris Ribble

Seasonal Water Conservation Tips for Autumn

To help guide us through the cooler, fall months, here are some tips and ideas on how to conserve water in the outdoors:

- **Change your sprinkler schedule.** As the weather cools down, plants and lawns don't need as much water... and when it's raining, they don't need to be watered at all. Change your sprinkler timer now and then remember to turn it off when it rains.
- **Get a jump on spring plantings.** Gardeners will tell you that plants set in the fall season require less water and will look better come springtime!
- **Invest in a rain barrel.** Consider using a rain barrel to collect and store rain water runoff throughout the wet months. Water collected can be used to water indoor or outdoor plants, when needed, instead of turning on your sprinklers.
- **Redirect downspouts to capture water.** Simply redirect downspouts outside your home to capture any rainwater and direct it to garden or plant areas.

For more water saving tips and ideas year-round, visit www.SaveOurWater.com

The 3rd Annual Mulch Magic Giveaway is a success!

June 6, 2018

Residents with trucks lined up before 7 am to load free shredded redwood mulch during NID's annual Mulch Magic Giveaway on June 2. By 12:30 pm, all of the piles of mulch – a total of 150 cubic yards – were gone!

In its third year, this year the giveaway had a new format – people collected the mulch on a first-come first-served basis at the Nevada County Fairgrounds instead of a voucher system to be redeemed at local suppliers.

The Mulch Magic Giveaway is part of NID's continuing efforts to promote conscientious water use and conservation. Mulch is a great tool to help save water in gardening and landscaping. Two or three inches of mulch helps retain water keeping the soil moist for longer periods of time.

The popular event is sponsored by NID, the Nevada County Resource Conservation District (NCRCD) and the Nevada County Fairgrounds.

WaterWays

Volume 39 • Number 4 • Fall 2018



Plan for Water

Join the Community Process. Visit PlanforWater.org

Planning today for our water supply in the future – get involved!

The process has begun to update the plan that will detail how our community's water will be managed for the next 50 years. And you are invited to participate!

There is nothing more vital than a secure water resource. Water irrigates farms that produce our food, offers protection from fire, helps power the economy, sustains the environment and flows from our faucets.

Water is a tough resource to manage in a drought-prone state like California. That's why long-term water resource planning is an urgent issue for us all.

We believe we can best plan our water future by teaming up with water users. To do this, we have initiated a two-year process called Plan for Water that will update NID's Raw Water Master Plan. Key to the process will be a 30-member group comprised of community representatives who will develop strategies, or pathways, that reflect a balanced mix of community perspectives. Learn more about the process and how to get involved at PlanforWater.org. Sign up to receive a newsletter [here](#).

Conservation: Cooler temps signal time to reduce outdoor water use

Cold nights and cooler days provide the opportunity to save water – and money – this fall and winter. Every drop truly counts year-round. Customers who avoid outdoor watering definitely are doing their part to conserve water and help the environment and their neighbors. About 30 - 60 percent of residential water is used outdoors.

Yards need much less water with the cooler weather and during the rainy season. You could save 55-100 gallons per day by stopping outdoor winter watering!

Another excellent way to conserve water is to wrap bare outdoor pipes, which are more likely to freeze in cold weather and later burst as they thaw. Other ways to be more water-wise include catching rainfall with a rain barrel or large bucket and using that water for indoor and outdoor plants.



Check out NID's "[Water Efficiency](#)" webpage for conservation tips and tools

- Measure your water use with a free online calculator
- Find tips to reduce the amount of water you use indoors
- Find tips to reduce the amount of water you use outdoors

Fourth Annual Mulch Magic Giveaway set for May 11 – come and get it

April 30, 2019

The 4th Annual Mulch Magic Giveaway will be held from 7-11 am on May 11 at the Nevada County Fairgrounds, Gate 8 off Brighton Street.

Nearly 150 cubic yards of shredded cedar will be handed out free on a first-come first-served basis, courtesy of Nevada Irrigation District and sponsors Nevada County Resource Conservation District (NCRCD) and the Nevada County Fairgrounds.

The event starts at 7 am at the Fairground's Gate 8, and goes until 11 am, or while supplies last.

The mulch is provided in bulk and will require a truck. This is a "self-load" event; participants are asked to provide their own shovels, containers and tarps to cover the loads. For those needing assistance, local Boy and Eagle Scouts will be available to help load mulch into vehicles.

The limit is 1 cubic yard of mulch (enough to fill a pick-up truck) per vehicle. The material is for personal use only; not for resale or commercial use.

Mulch is a great tool to help save water in gardening and landscaping. Two or three inches of mulch helps retain water keeping the soil moist for longer periods of time.

The Mulch Magic Giveaway is part of NID's continuing efforts to promote conscientious water use and conservation.

The location is the Nevada County Fairgrounds in the arena. Enter the Fairgrounds Gate 8 off Brighton Street.

For more information about the event, contact Kaycee Strong at 530-273-6185, ext. 244 or strongk@nidwater.com

Tremendous turnout for NID's Fourth Annual Mulch Magic Giveaway

May 20, 2019

Nearly 150 cubic yards of free shredded cedar mulch disappeared in less than two hours, during Nevada Irrigation District's 4th Annual Mulch Magic Giveaway on May 11.

Held at the Nevada County Fairgrounds, the event began at 7 am with mulch available free to local residents on a first-come first-served basis. By 8:30 am, the piles of mulch that filled much of the fairground arena were gone.

As a "self-load" event, participants are responsible for loading their own vehicles. For the first time this year, local Boy and Eagle Scouts were available to help shovel mulch, a service greatly appreciated by many.

NID provides the mulch, with the Nevada County Resource Conservation District (NCRCD) and the Nevada County Fairgrounds serving as sponsors.

The giveaway program is part of NID's continuing efforts to promote conscientious water use and conservation. Mulch is a great tool to help save water in gardening and landscaping. Two or three inches of mulch helps retain water, keeping soil moist for longer periods of time.

WaterWays

Volume 40 • Number 2 • Summer 2019

Rollins recreation pumps millions into local economy

Boating, camping and fishing at Rollins Reservoir provide millions of dollars in spending at nearby businesses and generates as many as 50 jobs for the region.

Nearly 108,000 people visited NID's Rollins Lake recreational facilities at Orchard Springs, Long Ravine, and Peninsula Resort campgrounds last year. In turn, those visitors spent \$4.87 million at convenience and grocery stores, gas stations, restaurants and other nearby businesses, according to a new study that measured the economic impact on the cities of Colfax, Chicago Park and Grass Valley.

NID collects fees from visitors that cover the cost of maintaining and operating the recreation areas, including paying dozens of seasonal employees.

The recreation areas are a positive-revenue generator and ensure that we have sustainable water year-round.

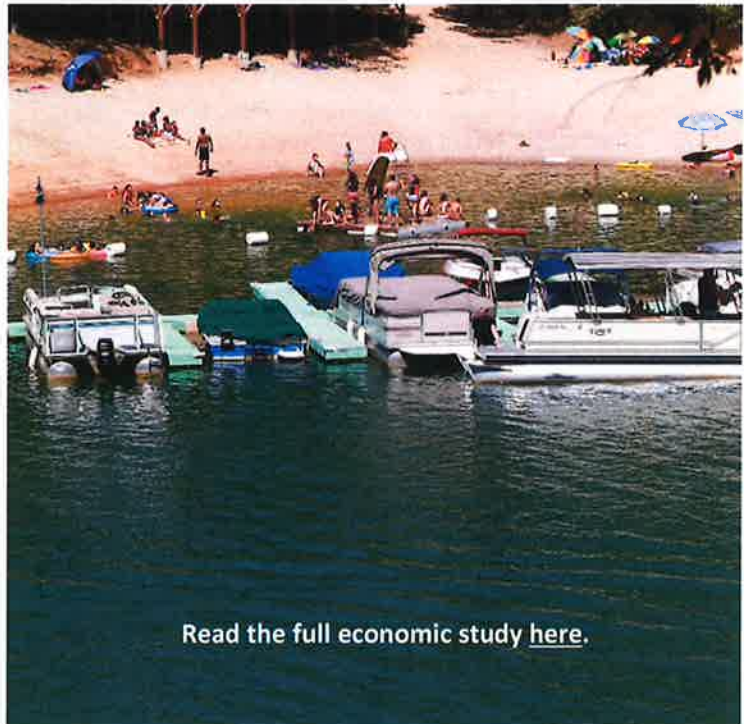

Read the full economic study [here](#).



New water meters will help track water use, detect leaks

New smart water meters will provide up-to-the-minute information on water use and can help customers conserve water – and save money.

NID has installed about 6,400 Badger meters for treated water customers. As old meters need to be replaced, the District will install the new technology, which features a cellular communication system that makes it easy for customers to track their water use, so they can better understand usage and identify leaks.



Kayakers enjoy the serenity of morning on Scotts Flat Reservoir during 2018's No Motor Day. Read more [here](#).

Save the Dates for Fun!

Bring the family and join in these fun events at NID Reservoirs and Campgrounds:

May 19: No Motor Day at Scotts Flat

Sept. 14: Kid's Triathlon at Orchard Springs

Sept. 15: BSM (Barbara Schmidt Millar) Triathlon at Cascade Shores Boat Launch



FREE MULCH Available for Pick-up



Saturday May 11, 2019

7:00 am – 11:00 am

Location: Nevada County Fairgrounds
Enter Fairgrounds Gate 8 off Brighton Street
Event will be held in Arena

SELF-LOAD

Bring your own shovels, containers, truck, and tarp to cover your load

Do you need help loading?

Local Boy and Eagle Scouts will be available to help load mulch into your vehicle.

Make sure to tip your Scout!

- First come, first served while supplies last
- For personal use only; not for resale or commercial use

Questions? Contact Kaycee Strong

530-273-6185 ext. 244 or strongk@nidwater.com

Mulch is a great tool to help save water. 2-3 inches of mulch helps retain water keeping the soil moist for longer periods of time.

****Limit 1 cubic yard per vehicle****



NID News Briefs

Community tour showcases NID's Forestry Project at Scotts Flat Reservoir

The NID Watershed team led an April 17 community tour of all of the work being done on District property around the reservoir to reduce fire fuels and protect against wildfire.

In its third year, the healthy forest project at Scotts Flat Campground addresses many factors that affect wildfire risk, watershed and forest health, and long-term water security. The two-hour tour was featured as part of *Know Your Watershed* month.

The Scotts Flat Fire Fuels Reduction and Healthy Forest Project is in partnership with the Sierra Nevada Conservancy and CAL FIRE. Projects like this one within the Deer Creek sub-watershed will restore and maintain healthy, fire-resilient landscapes, while protecting water supply and quality in central Nevada County.

NID supports the Nevada County STEAM Expo

NID was a sponsor of role in the annual Nevada County STEAM Expo, which motivates students to take an interest in science, technology, engineering, art and math. The event was coordinated by the Nevada County Superintendent of Schools and held at the Nevada County Fairgrounds on April 5-6.

On Friday, April 5, a team of NID employees judged student science projects. The District gave out 10 awards to recognize local youth that are working on and thinking about water resources, watershed health, and the environment.

On Saturday, April 6, NID hosted an information table in the "Career Exploration Wing" with fun activities and information to highlight employment opportunities for our local youth. The activities included a hands-on model of water system components and a hand-powered centrifuge that replicates the mercury removal process NID is using at Combie Reservoir during its award-winning sediment removal project (see p.1).

Scotts Flat wins two "best of" awards

Scotts Flat Reservoir has been voted best camping *and* best fishing spot in The Union Newspaper's annual "Best of Nevada County" awards competition. Scotts Flat also was voted runner-up for best boating location.

Every summer, about 60 seasonal employees join the Recreation Department's nine full-time staff members to assist the 240,000-plus annual campers and boaters who visit NID campgrounds and reservoirs.

In total, NID operates and maintains 15 campgrounds, plus camping sites in the Jackson Meadows-Bowman Lake areas.

Read more about NID recreation [here](#).

NID customers adopt water conservation as a way of life

Customers can feel good about their voluntary efforts to reduce water usage. In January, customers used 9 percent less treated water than in 2013, which is the first year of the worst drought in modern times and serves as a benchmark for water conservation measurements. In total for 2018, customers used 12 percent less treated water than in 2013.

This is an indication customers are embracing the concept that water conservation should be a way of life throughout the year, whether during the wet, cold winter or dry, scorching summer.

“Our new norm of water usage is well below that of the recent drought years,” said Chip Close, NID operations manager. “Thank you to NID customers who have voluntarily incorporated water conservation into their lifestyles. It is important to be responsible stewards of our water resources, and conservation is a crucial way to stretch our limited supply and be responsive to the effects of climate change and future drought.”

Now that winter is upon us, wetter weather means gardens and landscape do not need irrigation. There still are opportunities to conserve water. Find some easy water conservation actions at NID’s website [here](#):

- Use an online water usage calculator to see how much water your family really uses
- Install low-flow shower heads and shorten your shower. Showering accounts for nearly 17 percent of residential indoor water use – up to 40 gallons per day for an average family
- Improve the efficiency of your toilet with an old trick. Place a brick in the toilet tank. The brick displaces about half a gallon of water, which reduces the amount needed per flush. Plus, there’s little effect on the flush power.

NID welcomes new Directors

NID welcomes three new members to its Board of Directors. Ricki Heck (Division 1), Chris Bierwagen (Division 3) and Laura Peters (Division 4) joined Directors Nick Wilcox and Scott Miller on the Board.

Elected to four-year terms, NID Directors set policy to ensure a reliable, high-quality water supply for our farms, homes and businesses in Nevada and Placer counties. Read the bios of the Directors [here](#).

(From left to right) Laura Peters, Chris Bierwagen and Ricki Heck were inducted on Dec. 12, 2018.



Jacqueline Longshore named NID Maintenance Manager



Jacqueline Longshore during a fish rescue at the Scotts Flat plunge pool.

Congratulations to Jacqueline Longshore, who has been promoted to Maintenance Manager. In her new position she will oversee the activities of employees in Construction, Service, Facilities Maintenance and Fleet Maintenance.

Ms. Longshore started as a Senior Vegetation Control Worker with NID on June 6, 2011, and promoted to Assistant Maintenance Superintendent – Vegetation Control on May 6, 2013. She transferred to Hydroelectric as the Hydroelectric Program Analyst on Feb. 10, 2014, then promoted to Hydroelectric Compliance Administrator on May 19, 2018. On Jan. 7, 2019 her promotion to Maintenance Manager was announced after former Manager Brian Powell retired.

Prior to NID, Ms. Longshore worked for the California Department of Forestry and Fire Protection as a Forestry Assistant and Urban Forester. She holds a Bachelor’s Degree in Forestry and Natural Resources Management from Cal Poly, San Luis Obispo, and has a minor in water science and concentration in resources management.

NID News Briefs:



Finding the most effective, least toxic treatments for vegetation management

NID's Vegetation Management Crew completed aquatic vegetation treatments in October as part of the District's ongoing efforts to test and find alternatives to conventional herbicides.

NID keeps the water running for federal workers

NID gave a helping hand to Federal employee customers impacted by the government shutdown. NID worked with customers to develop payment plans and forego any fees and penalties associated with late payments.

Check out NID videos on YouTube:

Watershed Stewardship at Scotts Flat

NID places a high priority on watershed stewardship. Focused efforts improve the health of watersheds, which are our ultimate source of water. Learn about NID projects addressing forest health and fire risk at Scotts Flat Reservoir. Click [here](#).



NID's Vegetation Management Program

With more than 400 miles of canals in Nevada and Placer counties, weed control is a big job for NID boundaries. The District's integrated program aims to prevent algae and other growth from clogging canals, limiting access and affecting water deliveries. Click [here](#).

Water Conservation: Saving Water on the Farm through Drip Irrigation

This video profiles Rich Johansen, farmer who conserves water through drip irrigation on 12 organic acres in Penn Valley. Click [here](#).

South Yuba Canal

NID is purchasing PG&E's Deer Creek facilities, including the powerhouse, most of the South Yuba Canal and Chalk Bluff Canal. These are significant components for NID water deliveries to more than 30,000 people in Grass Valley and Nevada City. Click [here](#).

Sediment and Mercury Removal at Combie Reservoir

This pilot project aims to remove and clean about 80,000 cubic yards of sediment from Combie Reservoir to reduce elemental mercury in the Bear River watershed and restore water storage capacity in the reservoir. Click [here](#).



A group of kayakers enjoy the serenity of morning on Scotts Flat Reservoir during 2018's No Motor Day.

Save the Dates for Fun!

Bring the family and join in these fun events at NID Reservoirs and Campgrounds:

April 20: Easter Egg Hunt at Orchard Springs

May 19: No Motor Day at Scotts Flat

Sept. 14: Kid's Triathlon at Orchard Springs

Sept. 15: BSM (Barbara Schmidt Millar) Triathlon at Cascade Shores Boat Launch

Local Water Conservation

Thanks to NID customers who continue to make water conservation a way of life. It's typical for treated water usage to go up in the later spring months as people begin outdoor watering. This year, also facing COVID-19 restrictions, we have seen an increase of about 15 percent, comparing 2020 to 2019. However, we are using less water than in 2013, the benchmark year for pre-drought water consumption.

NID Treated Water Usage Comparison

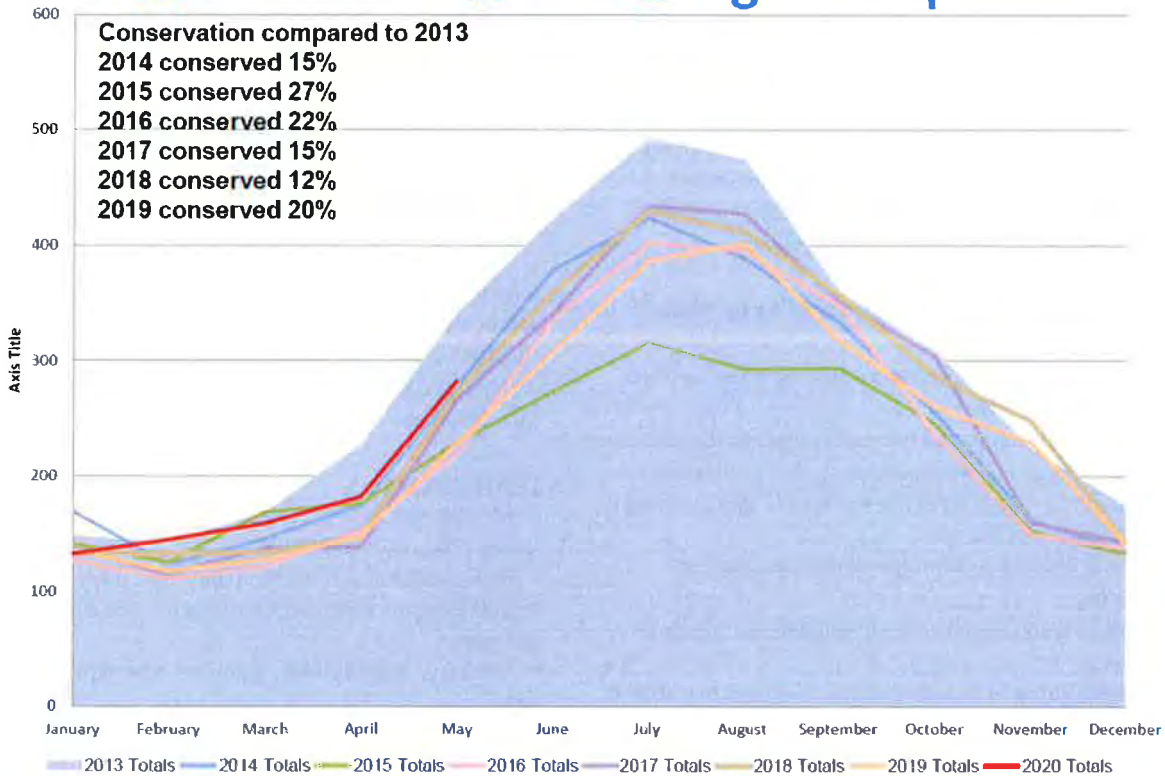

Conservation tips – reduce sprinkler waste

Use this checklist as you turn on your sprinkler/drip systems to ensure proper water use



CONNECT

A leak as small as a tip of pen can waste up to 6,300 gallons of water per month



INSPECT

A broken sprinkler can waste up to 25,000 gallons in six months



DIRECT

Be sure to spray on landscapes, not pavement

Controller

- * Replace batteries
- * Clean weather sensors
- * Adjust watering schedule

Sprinkler Heads

- * Adjust for adequate spray, coverage and run-off
- * Remove dirt/debris around heads
- * Check for broken, cracked, or clogged heads

Valves

- * Functioning properly?
- * Look for leaks

Wear and Tear

- * Inspect and replace worn nozzles, valves and pipes
- * Check water pressure for possible leaks

Mulch Magic





MULCH MAGIC VOUCHER

Valid April 1, 2016—June 30, 2016

Voucher # 101



Nevada County
Resource Conservation District
Your partner in conservation & agriculture

Voucher good for ½ cubic yard of shredded cedar mulch ONLY



Redeemable at:

RARE EARTH LANDSCAPE MATERIALS

11750 La Barr Meadows Road, Grass Valley CA 95945 530.477.9901

Ask About Getting
10% Off Your
Additional Purchase!
* Discount Valid Only with Voucher*

One Voucher Per Residence—Resident Signature

Authorized By (NID or NCRCD)

Sponsored by Nevada Irrigation District & Nevada County Resource Conservation District



The Magic Of Mulch



Nevada County
Resource Conservation District
Four seasons in conservation • participation

- ◆ Adding 2 to 3 inches of mulch around trees and plants can save more than 60 gallons of water per week for every 1,000 square feet of irrigated landscape.
- ◆ Mulch keeps soil moist and slows evaporation allowing water to sink into the soil.
- ◆ Mulch breaks down into the soil providing nutrients for plants.
- ◆ Mulch moderates soil temperature.
- ◆ Mulch suppresses weeds.

How Much Does 1 Cubic Yard of Mulch Cover?

Depth	Square Feet
1"	320
2"	160
3"	108
4"	80
5"	64



Sponsored by Nevada Irrigation District & Nevada County Resource Conservation District

LOCAL



'Mulch Magic'

NID, NCRCD to give away free mulch
Submitted to The Union

Placing mulch in your home landscape can work magic in conserving water, controlling weeds and building richer soils and healthier plants.

Beginning April 1 and for a limited time, free mulch is being made available to local residents.

The 'Mulch Magic Give-away' is being offered by the Nevada Irrigation District (NID) in partnership with the Nevada County Resource Conservation District (NCRCD), Rate Earth Landscape Materials and Four Season Landscape Materials. It is scheduled from April 1 through June 30, or as long as supplies last.

Community members may pick up vouchers at the NID or NCRCD offices and redeem the vouchers at either Rate Earth in Grass Valley or Four Seasons in Fern Valley.

Vouchers are good for up to a half cubic yard of shredded cedar or reprocessed bark mulch per resident. In all, approximately 100 cubic yards of mulch will be available.

The benefits of mulch are many, says NID Water Efficiency Technician Aurora Tipton.

"Adding two to three inches of mulch around trees and plants can help you save more than 60 gallons of water per week for every 1,000 square feet of irrigated landscape," she said.

Importantly, Tipton said, mulch keeps soil moist and slows evaporation, allowing the water to sink into the soil. Mulch moderates soil temperature, suppresses weed growth and provides nutrients to the soil.

Since opening their doors one year ago, NEO officials say they have seen great success with the Youth Center.

Submitted Photo by Momi Photography

A happy anniversary

NEO to celebrate Youth Center's first year open

Submitted to The Union

NEO will be celebrating the one-year anniversary of the Youth Center 7:30-8:50 p.m. Thursday, March 24.

NEO has teamed up with the Grass Valley, Nevada City, and Fern Valley Chambers of Commerce to make the celebration a joint chamber mixer. The entire community and people of all ages are invited to come join the celebration. The open house will include tours, live music and youth performances, and food provided by Smiley Guys Smokehouse.

The NEO Youth Center currently offers free after school drop-in hours for youth from the ages of 13-18. During the drop-in hours youth are engaged in various activities including homework help, ping pong, foosball, crafts, video games, board games, sports and more all in a safe and supervised environment. In addition, the center hosts workshops including yoga, dance and video game design as well as weekend events, such as concerts, dances, open mic nights, and

music nights.

Since opening their doors one year ago, NEO has seen great success with the Youth Center.

"We see more and more kids coming through our doors each week," explains Co-Director Lynn Skerleval, citing monthly attendance has increased every month since opening.

NEO sees an average of 19 youth per day, but on some days as many as 45 youth visit the center. Since September, NEO has seen a total over 1000 visits and currently has more than 200 unique members. The NEO Youth Center strives to create a warm, welcoming, and

engaging environment for all youth.

Youth Center attendee, Haysun Young says, "The Youth Center is awesome, you can't be bored here."

High school student, Mary Vogel explains, "Coming to NEO is like getting a warm cozy hug!"

"Our one-year anniversary at the Youth Center is an important milestone for us. Over the decades, there have been many attempts at starting youth centers in Western Nevada County, but none have ever made it to their second anniversary. We're proud to have made it this far. We're going strong and look forward to all that

we can accomplish in the coming year," said Skerleval.

NEO continues to look to the future by laying the ground work for their long-term vision of opening a multi-generational Youth & Community Center. In addition, NEO continues to host off-site events, teen sessions at larger community events, and school outreach at 9 area schools. NEO is a 501(c)(3) organization that was founded in 2008. NEO

strives to empower youth to make healthy life choices by providing New Events and Opportunities in a safe environment that encourages youth success and contributes to a healthier community.

To learn more visit neo.org or call 530-470-3869. The NEO Youth Center is located at 128 Joerschke Drive in Grass Valley, next to Bitney College Prep High School and Smiley Guys Smokehouse.

75% OFF Sales Every day!

Anew PLACE
Community Thrift & Resource Center
745 S. Auburn St., Grass Valley • 530-477-9111
Come shop...Come relax...
Come see what Anew Place has to offer!
Hours: Monday-Friday 10am-6pm • Saturday 10am-5pm
Each year we celebrate at Anew Place by offering Anew Day special sales and support that makes community members who are budget-minded & through hardships at the heart of the community.

Anew Day info@anewday.com
www.anew-day.com

CAREGivers Wanted

Must be at least 18 years old, US citizen and change the lives of the people around you

- Industry leading wages, \$11-13/hr.
- 401K plan with matching funds
- Nationally Awarding Paid Training
- 24hr CAREGivers can earn \$40-\$50K annually

Home Instead SENIOR CARE

Call us at 1-800-447-7667

Do You Know Your True Skin?

25% OFF ANY Recommended Treatment

We invite you to a **FREE** Visia Complexion Analysis so you can discover what your skin needs! We can determine your True Skin Age & its condition.

Education and Ease At Reflections Skin Oasis where the "Beauty of Everyday" begins today.

Reflections Skin Oasis
138 Colfax Ave. Suite 2, Grass Valley
www.reflectionsskinosis.com
530.274.9053

DORSEY MARKETPLACE

Public Open House

An opportunity to visit with friends and learn more about the proposed Dorsey Marketplace.

Wednesday, March 30, 2016
4pm-8pm
Foothills Event Center
400 Idaho Maryland Road
Grass Valley, CA 95945

dorseymarketplace.com



MULCH MAGIC VOUCHER

Valid April 26, 2017—June 30, 2017

Voucher # 300



Nevada County
Resource Conservation District
Your partner in conservation & agriculture

Voucher good for ½ cubic yard of bulk shredded redwood mulch ON-



Redeemable at:

FOUR SEASONS LANDSCAPE MATERIALS

17115 Penn Valley Drive, Penn Valley CA 95946 530-432-9906

**Ask About Getting
10% Off Your
Additional Purchase!**

One Voucher Per Residence—Resident Signature

Authorized By (NID or NCRCD)

Sponsored by Nevada Irrigation District & Nevada County Resource Conservation District

2018 MULCH MAGIC GIVEAWAY

FREE MULCH Available for Pickup

Saturday June 2, 2018

7:00am – 1:00pm

Location: Nevada County Fairgrounds Gate 8

****Limit 1 cubic yard per vehicle**
(enough to fill a pick up truck)**

Mulch is a great tool to help save water. 2-3 inches of mulch helps retain water keeping the soil moist for longer periods of time.



Nevada County
Resource Conservation District
www.ncrcd.org



**NEVADA COUNTY
FAIRGROUNDS**
California's Most Beautiful Fairgrounds

- First come, first served while supplies last
- For personal use only; not for resale or commercial use

Self Load ONLY
bring your own shovels,
containers, trucks,
and tarp to cover your load

Questions? Contact Kaycee Strong
530-273-6185 ext. 244 or strongk@nidwater.com



NID

2019 MULCH MAGIC GIVEAWAY

FREE MULCH Available for Pick-up



Saturday May 11, 2019

7:00 am – 11:00 am

**Location: Nevada County Fairgrounds
Enter Fairgrounds Gate 8 off Brighton Street
Event will be held in Arena**

SELF-LOAD

Bring your own shovels,
containers, truck,
and tarp to cover your load

Do you need help loading?

Local Boy and Eagle Scouts will be
available to help load mulch into your
vehicle.

Make sure to tip your Scout!

- First come, first served while supplies last
- For personal use only; not for resale or commercial use

Questions? Contact Kaycee Strong

530-273-6185 ext. 244 or strongk@nidwater.com

Mulch is a great tool to help save water. 2-3 inches of mulch helps retain water keeping the soil moist for longer periods of time.

****Limit 1 cubic yard per vehicle****



Nevada County
Resource Conservation District
www.ncrcd.org

Farm Days





WOW! 2nd Annual
FARM DAY

September 22nd at the
 Nevada County Fairgrounds!



This event is open to all 3rd graders in Nevada County. Space is limited and classes/students must register. Please contact the Nevada County Resource Conservation District/Jan Blake for more information.

(530) 272-3417 x103 • janet.blake@ncrcd.org



Springtime Sprinkler Checklist

Controller

- Replace batteries if necessary
- Clean weather sensors
- Adjust irrigation schedule



CONNECT

A leak as small as the tip of a pen can waste up to 6,300 gallons of water per month.

Sprinkler Heads

- Adjust for adequate spray, coverage, and run-off
- Remove dirt and debris around heads
- Check for broken, cracked, or clogged heads



INSPECT

A broken sprinkler can waste up to 25,000 gallons of water in 6 months.

Valves

- Functioning properly
- Look for leaks

Wear and Tear

- Inspect and replace worn nozzles, valves and pipes
- Check water pressure for possible leaks



DIRECT

Be sure to spray on landscapes, not pavement



Summertime Sprinkler Checklist

Controller

- Replace batteries if necessary
- Clean weather sensors
- Adjust irrigation schedule



CONNECT

A leak as small as the tip of a pen can waste up to 6,300 gallons of water per month.

Sprinkler Heads

- Adjust for adequate spray, coverage, and run-off
- Remove dirt and debris around heads
- Check for broken, cracked, or clogged heads



INSPECT

A broken sprinkler can waste up to 25,000 gallons of water in 6 months.

Valves

- Functioning properly
- Look for leaks

Wear and Tear

- Inspect and replace worn nozzles, valves and pipes
- Check water pressure for possible leaks



DIRECT

Be sure to spray on landscapes, not pavement



How to Detect a Water Leak

- **Check meter for running water**

Sensus Meters: Look for red dial spinning– indicating water flowing through meter

Badger Meters: Numbers on the right hand side will be moving– indicating water flowing through meter

- **Verify leak with a timed meter test**

Step 1: Locate meter and write down all numbers showing

Step 2: Don't use water for 30-60 minutes

(Including swimming pools, ice-cube maker, landscape irrigation, etc.)

Step 3: Verify the numbers on the meter are the same

***If the numbers are different, water ran through the meter during that time and you likely have a leak.*

- **Isolating leak**

Step 1: Locate the shut off valve at the home and turn it off.

Step 2: Look at meter. If water is still flowing through the meter, the leak is located in the pipes between the meter and the shut off valve to the home.

***If the meter is not moving the leak is beyond that shut off valve.*

Questions? Call NID

530-273-6185



How to Water & Irrigate

How Long Do I Need to Water?

One of the easiest ways to save water is to make sure that you are not overwatering your lawn and plants. Most of us water more than we need to, which not only wastes water but ends up drowning our plants. Watering for fewer days for the appropriate amount of time will give you healthier plants and use less water.

Here are some general guidelines on how to make sure that you are watering the correct amount. For specific information on your landscape, this run time [calculator tool](#) by Rain Bird can help you design a specific plan for your landscape. Rain Bird's ["When and How Much to Water"](#) video may also help you figure out how much water is the right amount for your landscape.

1. Irrigation for lawn areas can be kept to three days in the summer with "run and soak" cycling of an irrigation valve/station.
 - For example, Program A for sunny lawn areas, can have three start times, three minutes with 30-60 minutes between each run time.
 - Be aware that sun exposure and slope of the lawn area are factors to consider in calculating the amount of time the irrigation runs. Shaded lawn does not need as much water.
 - Ensure irrigation water does not result in runoff.
2. Mature shrubs can usually be limited to watering two days a week in the summer.
 - Be aware that sun exposure and slope of the landscape areas are factors to consider in calculating the amount of time the water runs
 - Check [Sunset's Plant Finder](#) to determine if your plants are high, medium, or low water use.
 - Water in cycles (e.g. 5 minutes of run time with time in between to allow water to soak through to the plant's root zone). Run times will depend on the plant type.
 - Watering with this technique encourages deep rooting by water percolating to depths of at least several inches into the soil for shrubs, deeper for trees.
 - Ensure irrigation water does not result in runoff.
3. Once the root system is strong and deep enough, the plants will withstand more periods of no irrigation, particularly when the day length is shortened and the soil temperatures are cooler.
4. Annuals or water-loving plants can be efficiently irrigated with this method as long as they are rooted into the native soil. On new plantings, make sure the root ball is moist as well as the surrounding soil to encourage rooting beyond the original container size.



5. Apply 2-3" of mulch on any bare soil to keep soil temperatures cool.

What is Drip Irrigation?

Drip irrigation is the slow, precise application of water directly to the plants' root. A drip irrigation, micro irrigation, system can be customized to meet your landscape's specific needs while maintaining an optimum moisture level for your plants, efficiently conserving water that might otherwise be lost.

The Benefits of Drip Irrigation

Drip irrigation is an efficient and economical method of watering. Experts say that drip irrigation is at least 90 percent more efficient than other irrigation methods and reduces runoff and evaporation. Drip irrigation applies the water slowly where it is needed—at the plant's roots.



Commonly used in commercial nursery and agricultural operations, homeowners are beginning to take advantage of its uses and benefits.

Drip irrigation involves placing tubing with emitters on the ground alongside the plants. The emitters slowly drip water into the soil at the root zone. With this slow, appropriate direct application of water, plant health and growth is improved. In addition, drip irrigation:

- Prevents disease.
- Reduces weed growth.
- Saves time and water.
- Requires less work and maintenance.

What Is a Smart Controller?

Automatic sprinkler systems are run by a controller. Just as technology has improved cell phones and other devices in our lives, so has technology changed residential sprinkler system controllers.

“Smart” controllers act like a thermostat for your sprinkler system—telling it when to turn on and off and using local weather conditions to create a personalized watering schedule that matches actual conditions at your house. Instead of requiring the homeowner to set a schedule, smart controllers use real-time weather information to create a watering schedule that better matches plants' water needs. The EPA estimates that a household that replaces a standard clock timer with smart controller can save nearly 8,800 gallons of water annually.



Why is Saving Water Important?

With the recent changes in weather patterns, we are experiencing more extremes such as multiple drought years or more precipitation falling as rain instead of snow. In the upper watersheds, snowpack is very important as it provides water into the summer and fall months. With limited water storage capabilities, water conservation becomes a must for everyone.

NID water is used for human consumption, agriculture, recreation, hydropower and the environment.

The California Conservation Act of 2009 requires customers to reduce their water usage 20% by the year 2020.

Water conservation is everyone's responsibility in order to ensure a high quality, reliable water supply now, and into the future.



French Lake Elevation ft. 6,678

Serving Our Customers Since 1921

- ◆ Irrigation Water
- ◆ Drinking Water
- ◆ Recreation
- ◆ Hydro Power

Visit www.nidwater.com for water saving tips and try the "Water Calculator" link to determine your home's water usage. Contact the NID Water Efficiency Department for more information and assistance.

Contact the UC Master Gardeners for free assistance with planting information at www.ceplacer@ucdavis.edu



Nevada Irrigation District
1036 W. Main Street
Grass Valley, CA 95945
Tel: 530-273-6185
www.nidwater.com



Lower Scotts Flat Lake

WATER CONSERVATION

Preserving Water, One Gallon at a Time Because Every Gallon Counts

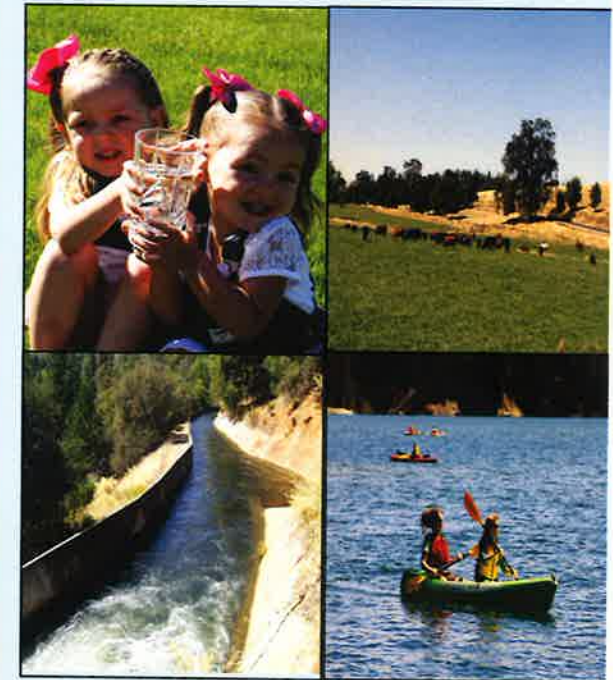

Nevada Irrigation District



water efficient

L A N D S C A P E S

In California, the largest use of all urban water is watering landscapes. When a landscape or irrigation system is poorly designed or poorly maintained, or the landscape consists of plants not suited to the dry and often hot California climate, water demand increases as a result of excessive evaporation, leaks, and runoff. Water consumption can be greatly reduced with careful planning, good plant selection, efficient irrigation systems, and good water management and maintenance practices.

Since California experiences frequent and sometimes prolonged droughts together with an ever increasing demand, there is a great need for us to use water efficiently. But this doesn't mean we have to give up our gardens. We can use water more efficiently and still have colorful, esthetically pleasing landscapes—including some turf areas for recreation.

This brochure is intended to help you create a landscape that is not only water efficient, but attractive, colorful, and low maintenance.

The designs illustrated here are typical back yards, but the principles of water efficient gardening apply to front yards as well.



NEVADA IRRIGATION DISTRICT

DEMONSTRATION GARDENS

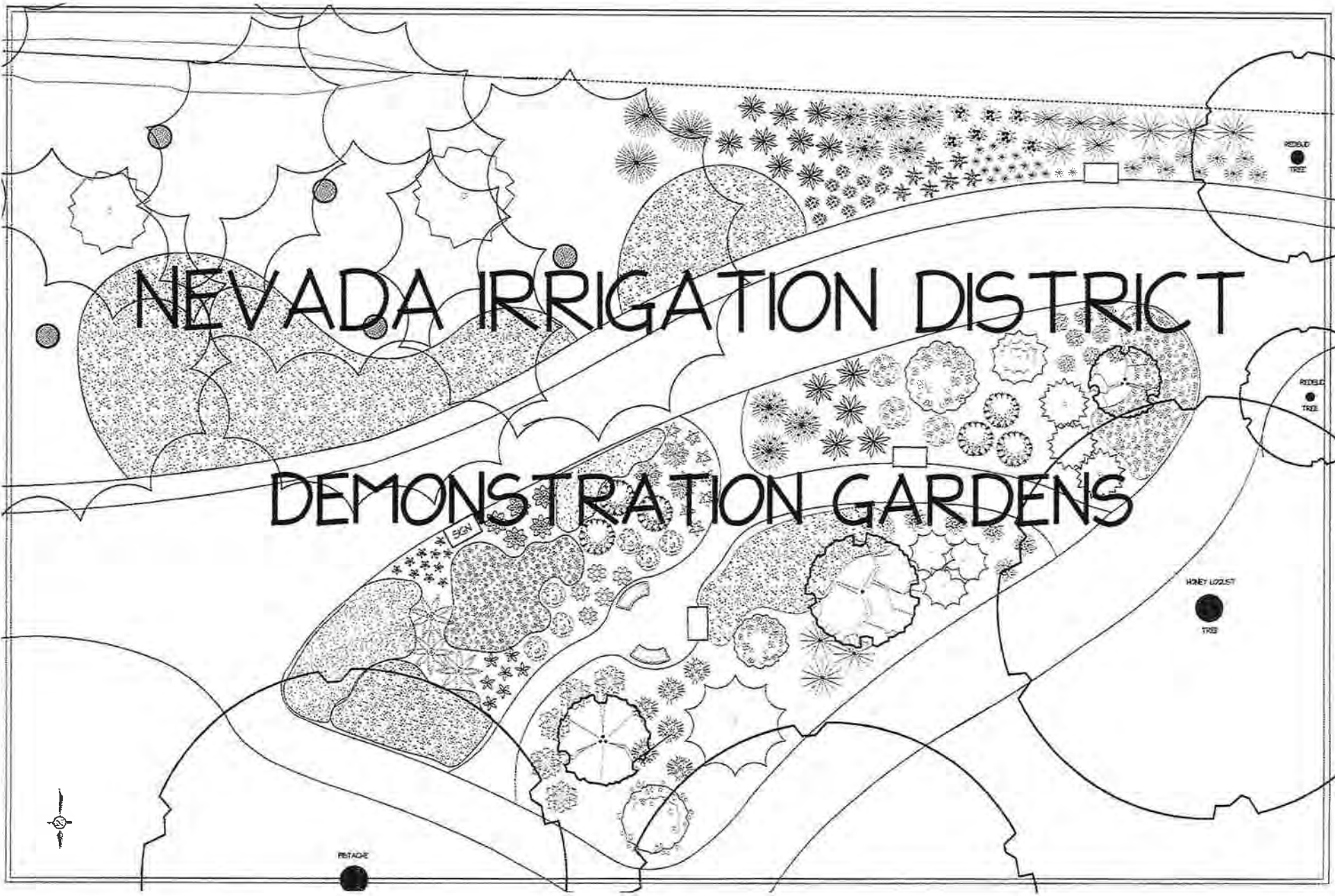

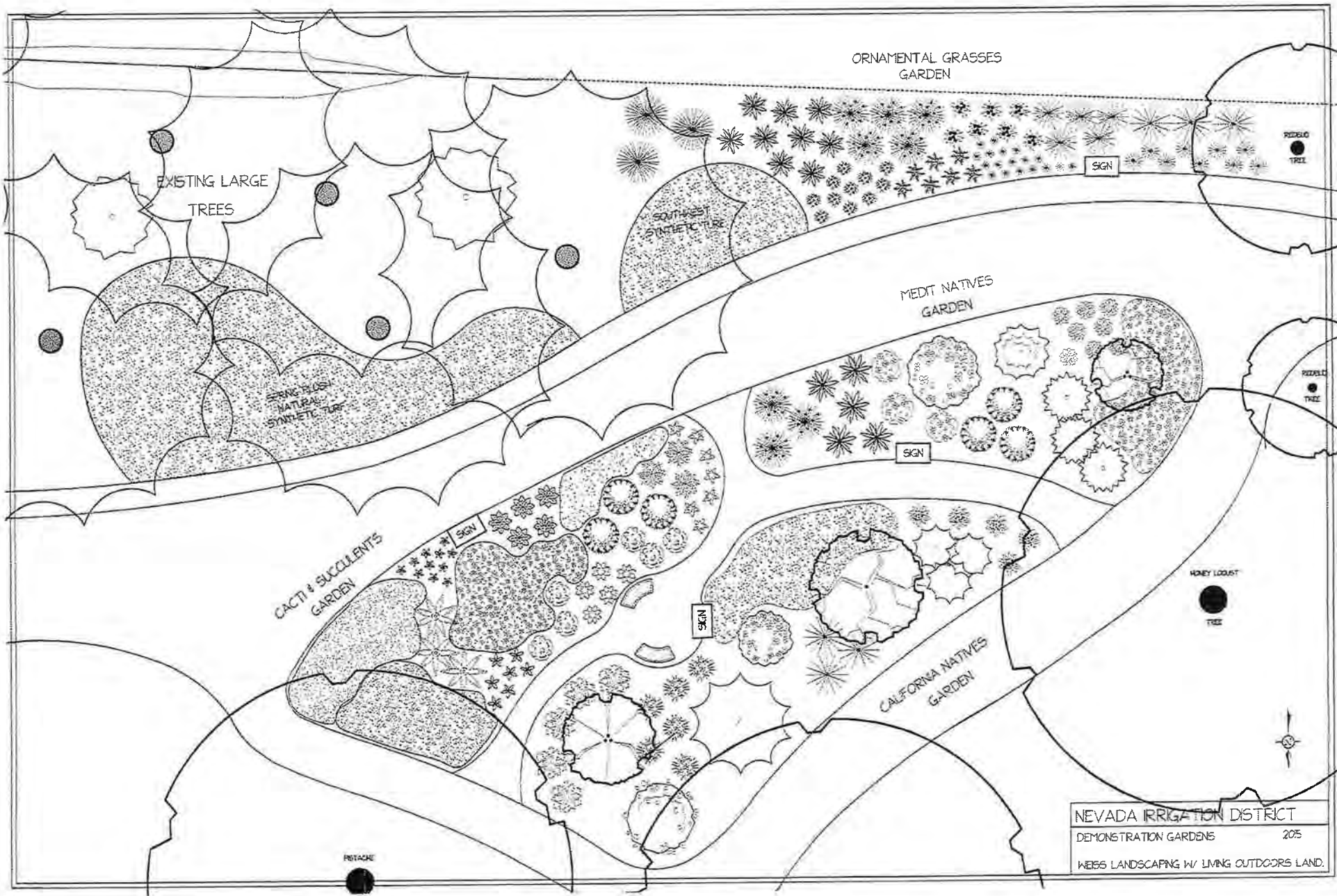

MEDITERRANEAN NATIVES GARDEN

IRRIGATED WITH:
PRECISION SPRAY NOZZLES

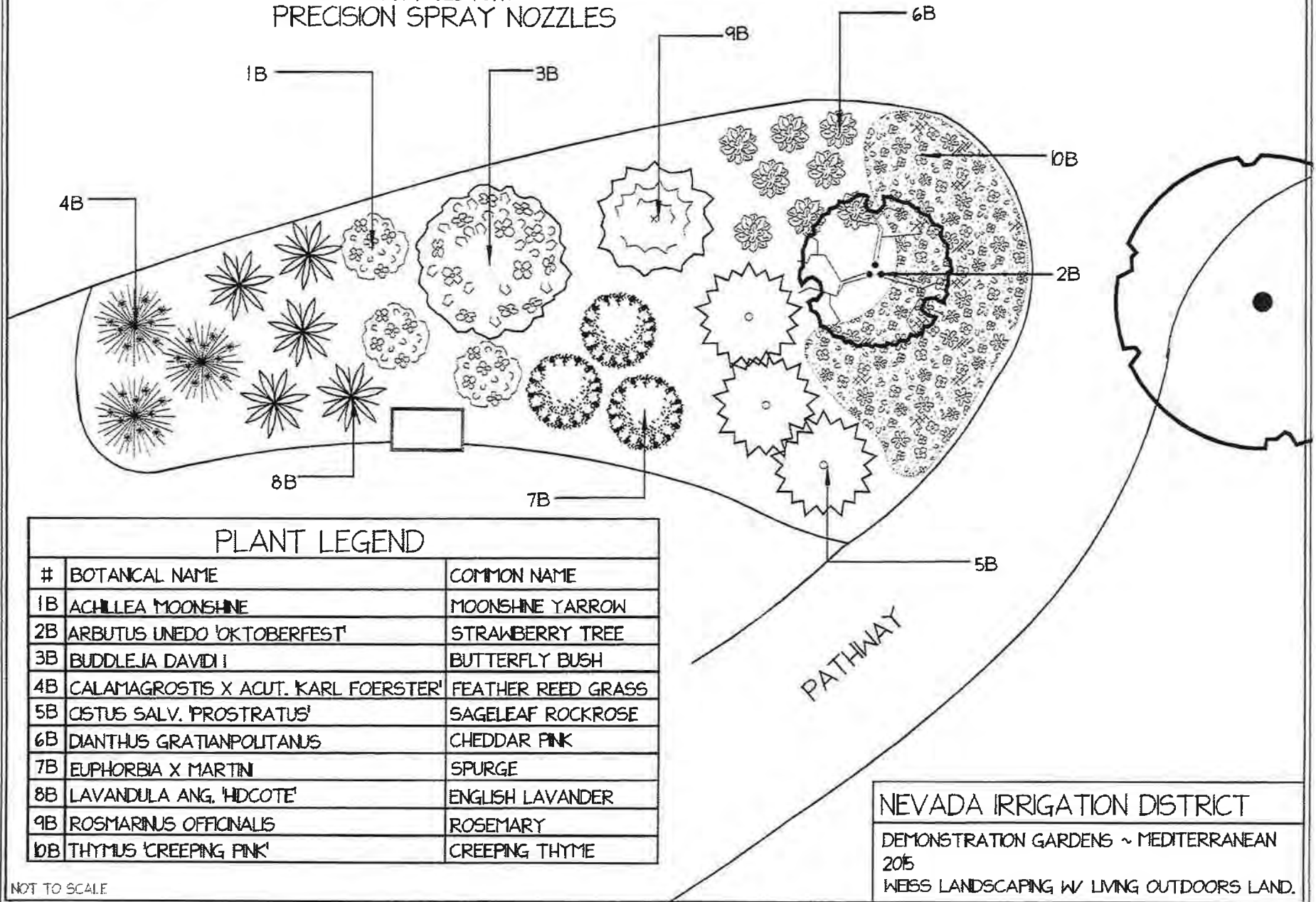

PLANT LEGEND

#	BOTANICAL NAME	COMMON NAME
1B	ACHILLEA MOONSHINE	MOONSHINE YARROW
2B	ARBUTUS UNEDO 'OKTOBERFEST'	STRAWBERRY TREE
3B	BUDDLEJA DAVIDI	BUTTERFLY BUSH
4B	CALAMAGROSTIS X ACUT. 'KARL FOERSTER'	FEATHER REED GRASS
5B	CISTUS SALV. 'PROSTRATUS'	SAGELEAF ROCKROSE
6B	DIANTHUS GRATIANPOLITANUS	CHEDDAR PINK
7B	EUPHORBIA X MARTIN	SPURGE
8B	LAVANDULA ANG. 'HDCOTE'	ENGLISH LAVANDER
9B	ROSMARINUS OFFICINALIS	ROSEMARY
10B	THYMUS 'CREEPING PINK'	CREEPING THYME

NEVADA IRRIGATION DISTRICT

DEMONSTRATION GARDENS ~ MEDITERRANEAN
2015

WEBS LANDSCAPING W/ LIVING OUTDOORS LAND.

NOT TO SCALE

TORO-IRRIGATION DIVISION

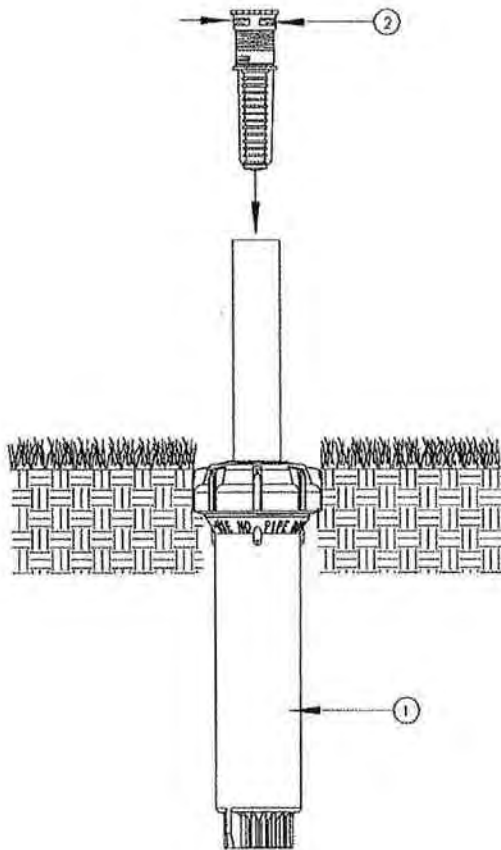
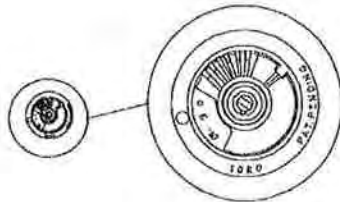

LEGEND:

① 570Z SPRAY HEAD 2", 3", 4", 6", 12" OR SHRUB
(PRX-COM RECOMMENDED)

② PRECISION

③ USE CHECK VALVES ON SLOPES AND WHEN
HEADS ARE INSTALLED BELOW GRADE.

○ PRECISION_s-2-FINELIGHT

NID
Mediterranean Natives

1. *Achillea 'Moonshine'*
Moonshine Yarrow



2. *Arbutus unedo 'Oktoberfest'*
Strawberry Tree



3. *Buddleja davidii*
Butterfly Bush



4. *Calamagrostis 'Karl Forester'*
Feather Reed Grass



5. *Cistus salvifolius 'Prostratus'*
Sageleaf Rockrose



6. *Dianthus gratianopolitanus*
Cheddar Pink



8. *Lavandula angustifolia* 'Hidcote'
English Lavender



10. *Thymus* 'Creeping Pink'
Creeping Thyme



7. *Euphorbia x martini*
Spurge



9. *Rosmarinus officinalis*
Rosemary



ORNAMENTAL GRASSES GARDEN

IRRIGATED WITH:
NETAFIM DRIPLINE

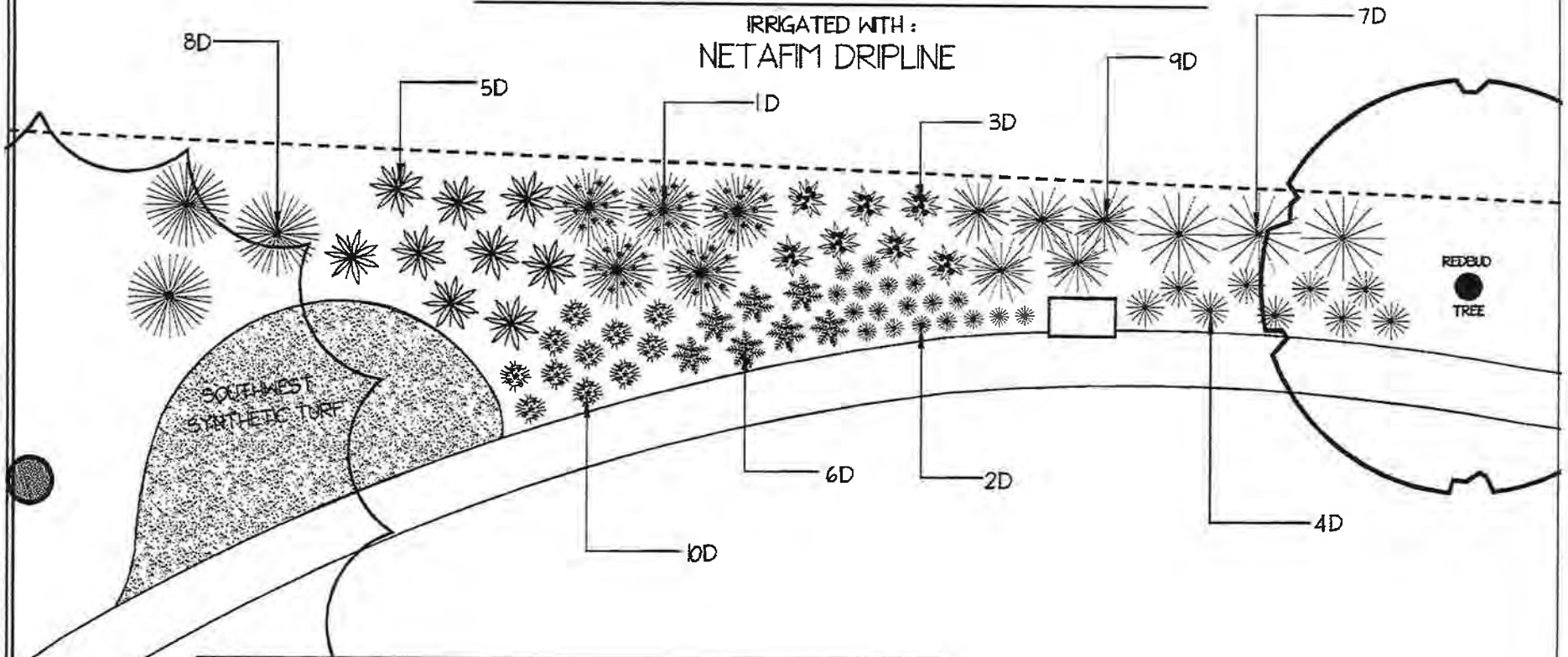

PLANT LEGEND

#	BOTANICAL NAME	COMMON NAME
1D	CALAMAGROSTIS X ACUT. 'KARL FOERSTER'	FEATHER REED GRASS
2D	CAREX TESTACEA	NEW ZEALAND SEDGE
3D	CHASMANTHUM LATIFOLIUM	SEA OATS
4D	FESTUCA GLAUCA	BLUE FESCUE
5D	HELECTOTRICHON SEMPERVIRENS	BLUE OAT GRASS
6D	LIRIOPE MUSCARI 'SILVERY SUNPROOF'	LILY TURF
7D	MISCANTHUS SINENSIS	SILVER GRASS
8D	MISCANTHUS SIN. 'STRICTUS'	SILVER GRASS
9D	PANICUM VIRGATUM	SWITCH GRASS
10D	PENNISETUM ALOPECUROIDES 'LITTLE BUNNY'	FOUNTAIN GRASS

NEVADA IRRIGATION DISTRICT

DEMONSTRATION GARDENS ~ ORNAMENTAL
GRASSES
2015
WEBB LANDSCAPING W/ LIVING OUTDOORS LAND.

NOT TO SCALE

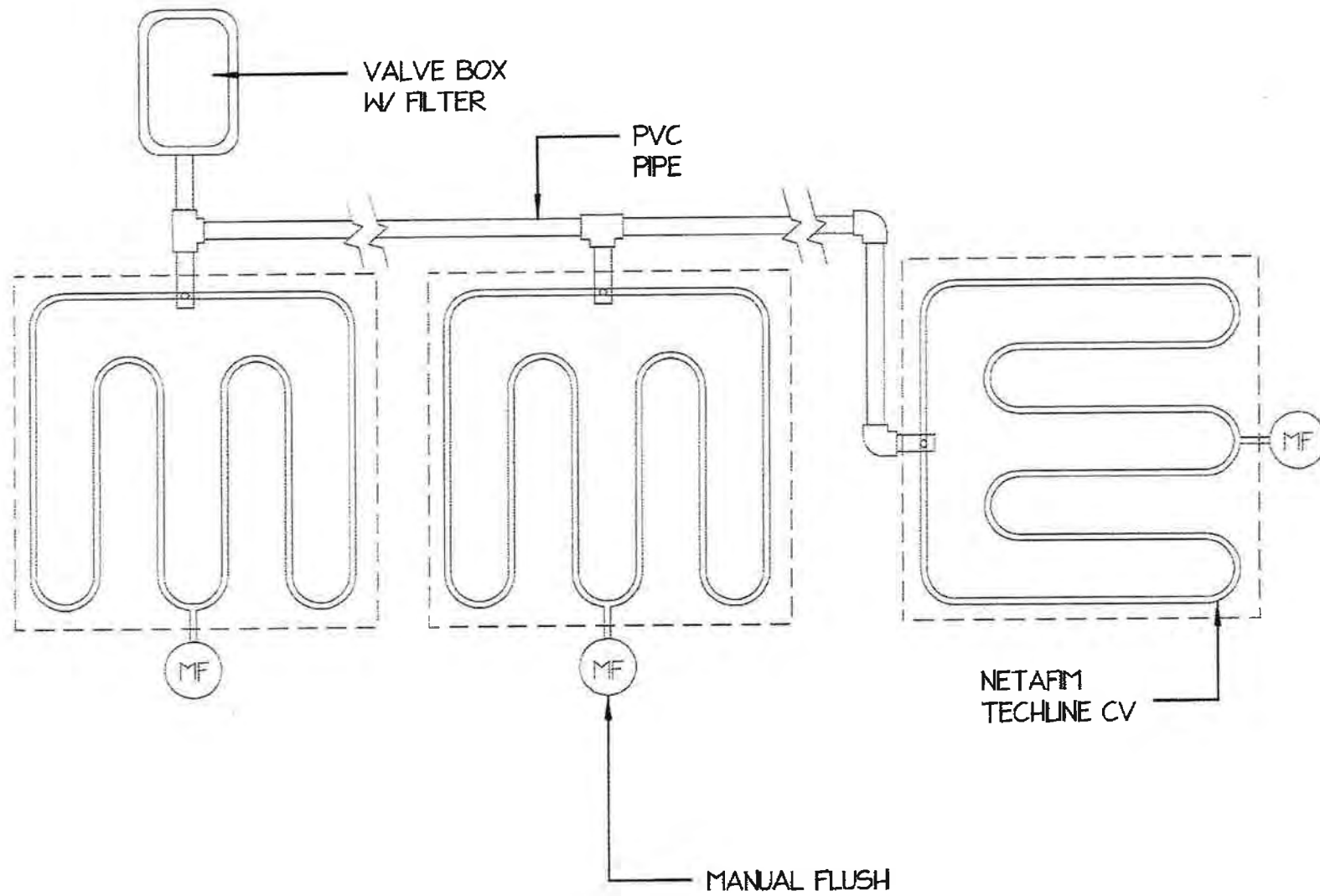

NID
Ornamental Grasses Garden

1. *Calamagrostis 'Karl Forester'*
Feather Reed Grass



2. *Carex testacea*
New Zealand Sedge



3. *Chasmanthium latifolium*
Sea Oats



4. *Festuca glauca*
Blue Fescue



5. *Helictotrichon sempervirens*
Blue Oat Grass



6. *Liriope muscari* 'Silvery Sunproof'
Lilyturf



7. *Miscanthus sinensis*
Silver Grass



8. *Miscanthus sinensis* 'Strictus'
Silver Grass



9. *Panicum virgatum*
Switch Grass



10. *Pennisetum alopecuroides* 'Little Bunny'
Fountain Grass



PLANT LEGEND

#	BOTANICAL NAME	COMMON NAME
1C	AGAVE BRACTEOSA	SPIDER AGAVE
2C	AGAVE PARRYI	AGAVE
3C	DELOSPERMA COOPERI	ICE PLANT
4C	DUDLEYA FARINOSA	DUDDLEYA
5C	EUPHORBIA CHARACIAS SSP. WULFENII	SPURGE
6C	SEDUM ACRE	GOLDMOSS SEDUM
7C	SEDUM 'AUTUMN JOY'	AUTUMN JOY SEDUM
8C	SEDUM RUPESTRE 'ANGELINA'	ANGELINA SEDUM
9C	SEDUM SPATHULIFOLIUM	PACIFIC STONECROP
10C	SEDUM SPURUM 'VOODOO'	VOODOO STONECROP
11C	SEMPERVIRENS TECTORUM	HENS-N-CHICKS
12C	SENECIO CINERARIA	DUSTY MILLER
BC	YUCCA FILAMENTOSA	ADAM'S NEEDLE

CACTI & SUCCULENTS GARDEN

IRRIGATED WITH:
DURA-FLO JR. DRIPPERLINE &
XERIPOP SPRAY HEADS

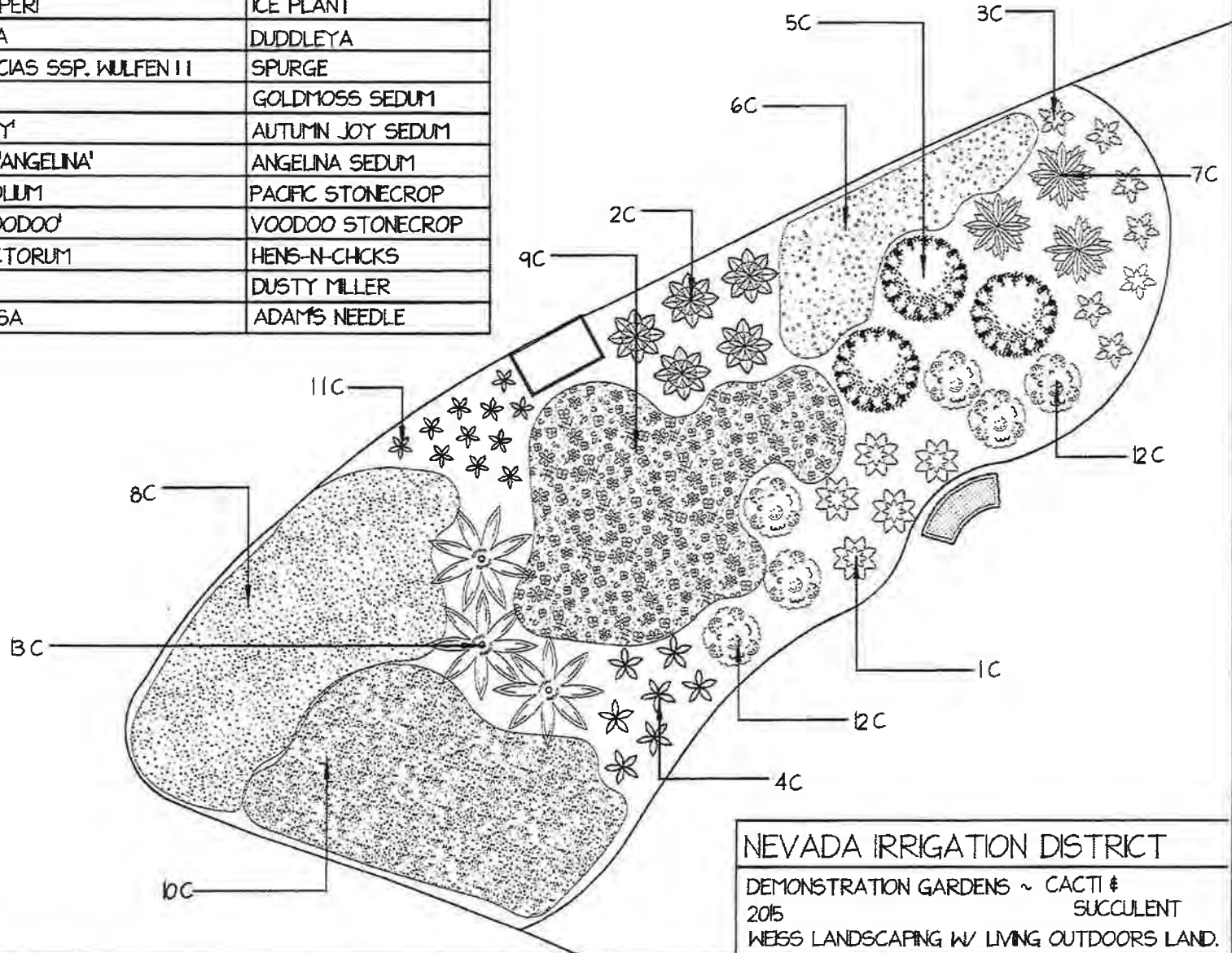

NEVADA IRRIGATION DISTRICT

DEMONSTRATION GARDENS ~ CACTI &
2015 SUCCULENT
WEISS LANDSCAPING W/ LIVING OUTDOORS LAND.

NOT TO SCALE



DURA-FLO™ JR DRIPPERLINE
NOT TO SCALE

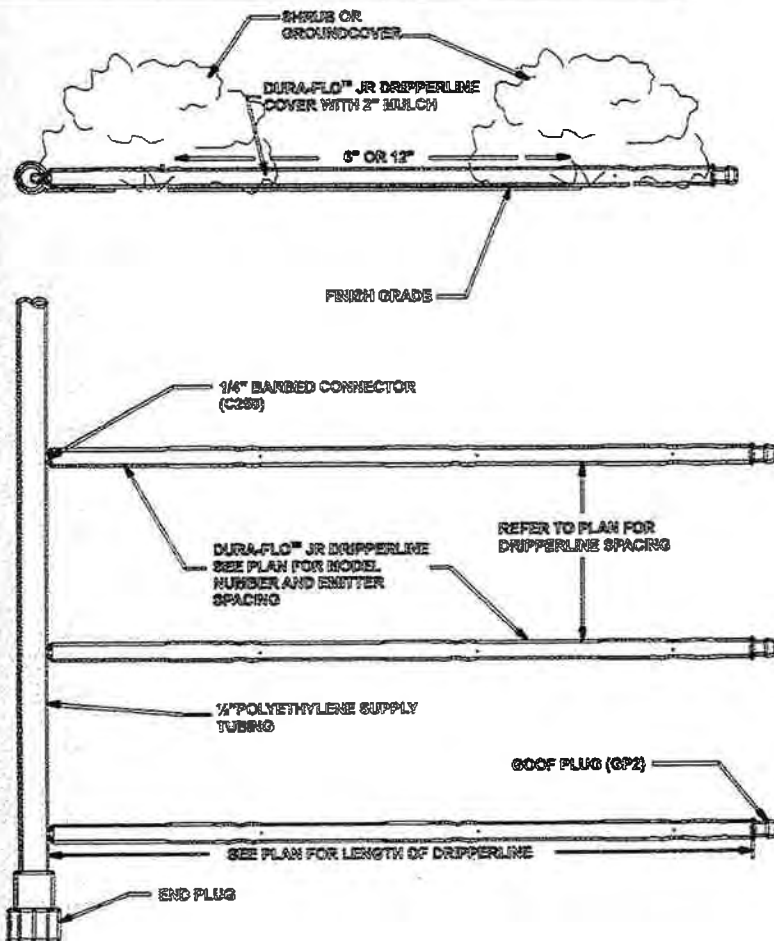

XERI-POP MICRO-SPRAY 6' FROM BARBED CONNECTOR INTO 1/2" POLYETHYLENE

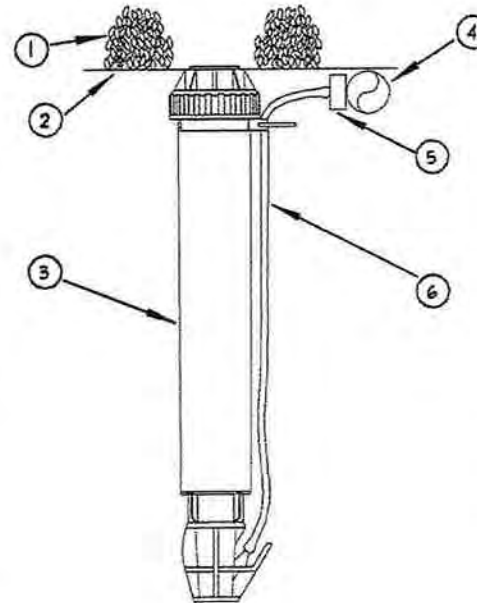

- ① PLANT MATERIAL
- ② FINISH GRADE
- ③ MICRO-SPRAY POP-UP:
RAN BRD XERI-POP XP-600X
- ④ From nelsco; 1/2"x5/16"x1/4"x286x; POLYETHYLENE TUBING:
RAN BRD XF SERIES TUBING OR
RAN BRD XT-700 XERI-TUBE OR
RAN BRD XBS BLACK STRIPE TUBING H0.9999PBx;
- ⑤ From nelsco; 1/2"x5/16"x1/4"x286x; SELF-PERCING BARB CONNECTOR:
RAN BRD SPB-025
- ⑥ From nelsco; 1/2"x5/16"x1/4"x286x; DISTRIBUTION TUBING:
RAN BRD XQ TUBING
(LENGTH AS REQUIRED)

NOTE
1. RAN BIRD XERI-POP CAN UTILIZE THE FOLLOWING NOZZLES:
SQ SQUARE NOZZLE (FORMERLY XPCN)
5 SERIES MPR NOZZLES (ALL CONFIGURATIONS)
5 SERIES PLASTIC BUBBLERS
8 SERIES MPR NOZZLES (8H, 8T AND 8Q)

NID
Cacti & Succulents Garden

1. *Agave bracteosa*
Spider Agave



2. *Agave parryi*
Agave



3. *Delosperma cooperi*
Ice Plant



4. *Dudleya farinose*
Duddleya



PLANT LEGEND

#	BOTANICAL NAME	COMMON NAME
1A	AQUILEGIA FORMOSA	WESTERN COLUMBINE
2A	ARTEMISIA CALIF. 'MONTARA'	CA. SAGEBRUSH
3A	CALYCANTHUS OCCIDENTALIS	SPICE BUSH
4A	CAREX PANSA	CA MEADOW SEDGE
5A	CERCIS OCCIDENTALIS	WESTERN REDBUD
6A	CORNUS NUTTALL II	PACIFIC DOGWOOD
7A	FREMONTODENDRON CALIF.	CA FLANNEL BUSH
8A	MUHLENBERGIA RIGENS	DEER GRASS
9A	PENSTEMON HETEROPHYLLUS	FOOTHILL PENSTEMON
10A	SALVIA CLEVELAND II	CA. BLUE SAGE
11A	ZAUSCHNERIA CALIF.	CA FUCHSIA

CALIFORNIA NATIVES GARDEN

IRRIGATED WITH:
MP ROTATOR SPRINKLERS

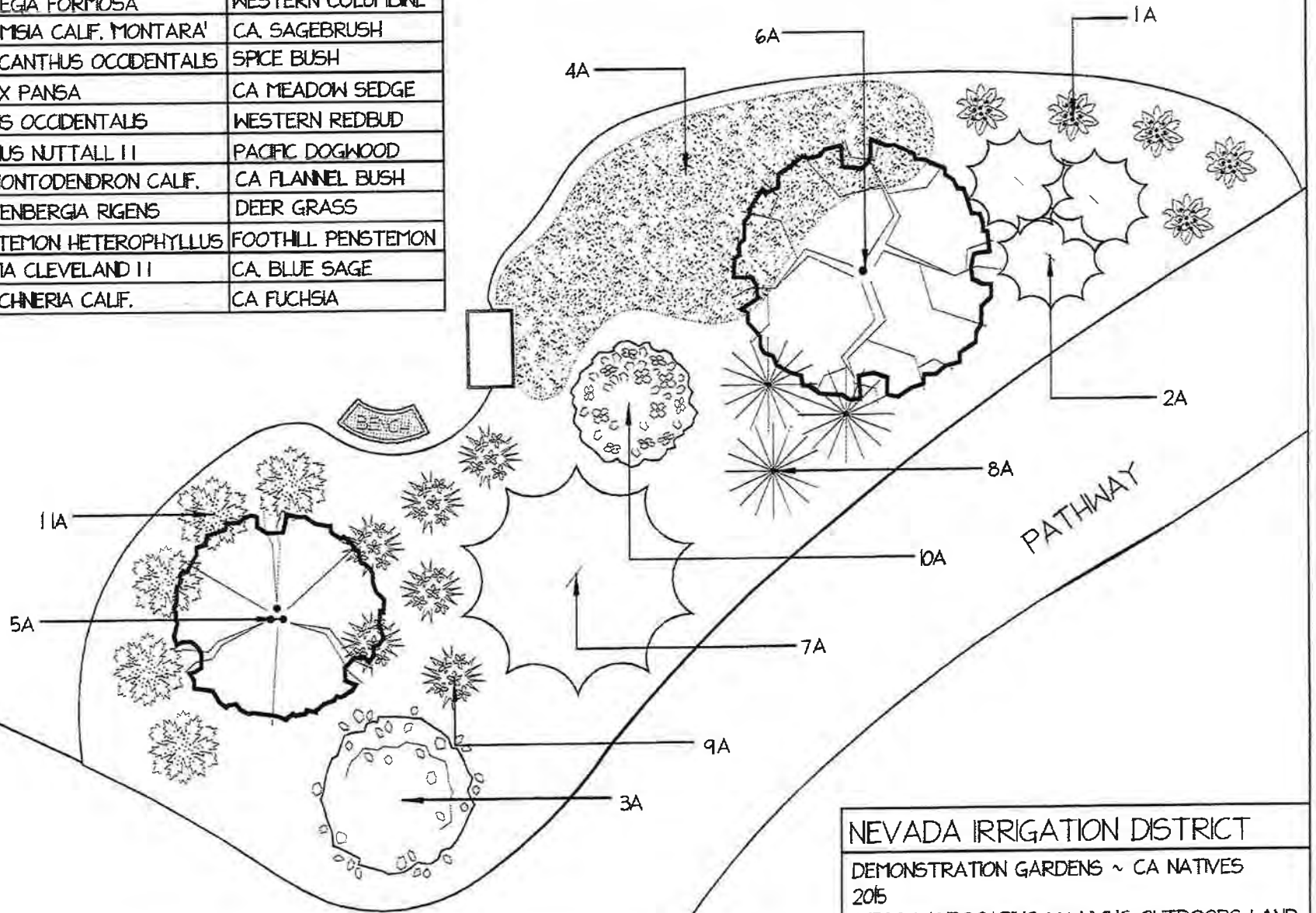

NEVADA IRRIGATION DISTRICT

DEMONSTRATION GARDENS ~ CA NATIVES
2015

WEISS LANDSCAPING W/ LIVING OUTDOORS LAND.

NOT TO SCALE

- ① FINISH GRADE
- ② MODEL PROS-06-PRS40-CV
- ③ LATERAL TEE OR ELL
- ④ LATERAL PIPE
- SWING JOINT:
- ⑤ HUNTER 'PRO-FLEX' TUBING, HSBE-050 ELBOWS (2), & MARLEX STREET ELBOW (1)

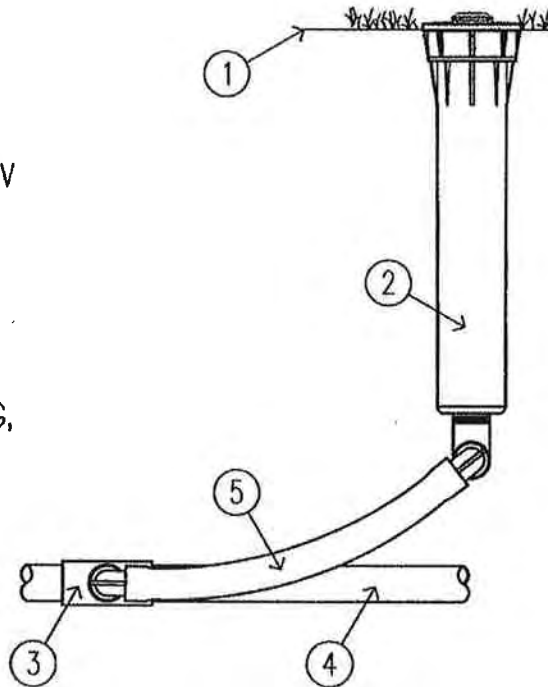

XX

PROS-06-PRS40-CV MP ROTATOR SPRINKLER

SCALE: 3" = 1'-0" Hunter IRRIGATION DETAIL

NID
California Natives Garden

1. *Aquilegia formosa*
Western Columbine



2. *Artemisia californica* 'Montara'
California Sagebrush



3. *Calycanthus occidentalis*
Spice Bush



4. *Carex pansa*
California Meadow Sedge



5. *Cercis occidentalis*
Western Redbud



7. *Fremontodendron californicum*
Flannel Bush



6. *Cornus nuttallii*
Pacific Dogwood



8. *Muhlenbergia rigens*
Deer Grass



9. *Penstemon heterophyllus*
Foothill Penstemon



10. *Salvia clevelandii*
California Blue Sage



11. *Zauschneria californicum*
California Fuchsia



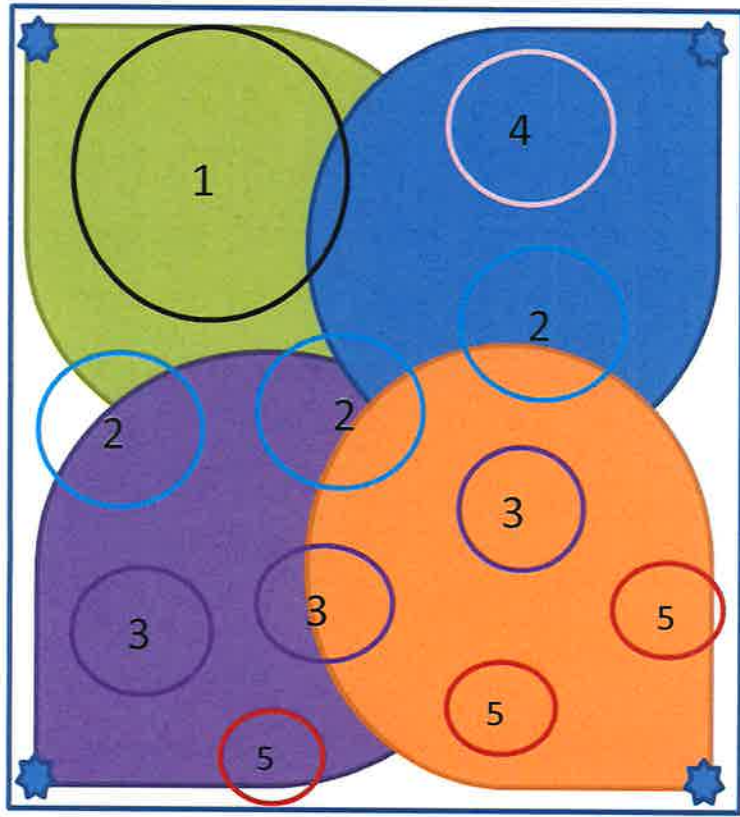

15'

10.5'

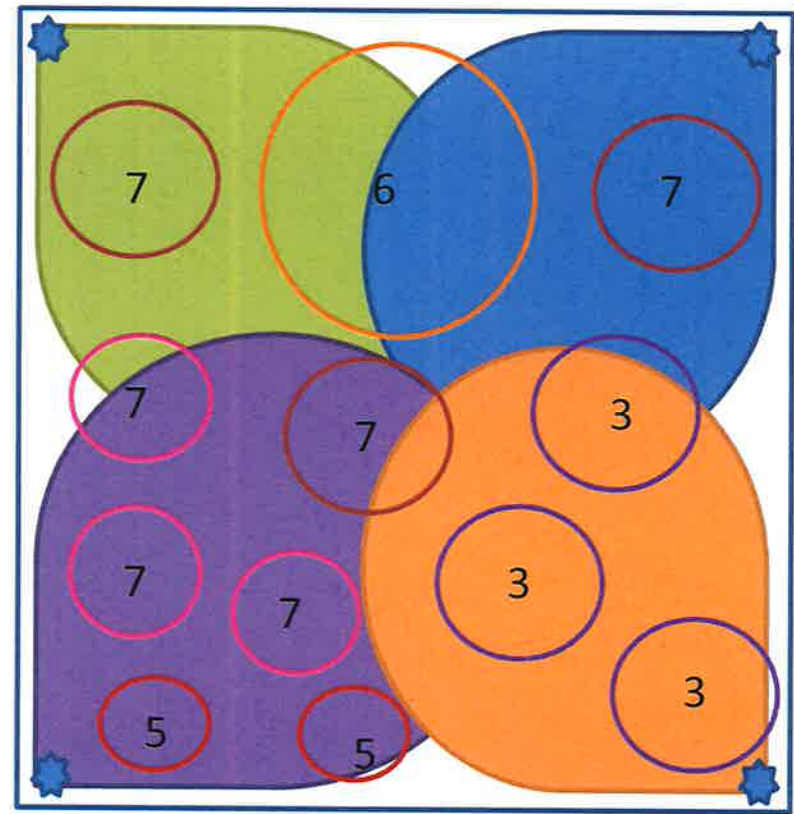

15'

11.5'

Water Efficiency Landscape Upgrade
 Purchasing Department

1. Buddelia, Butterfly Bush
2. Zauschneria, California Fuschia
3. English Lavender
4. Salvia, California Blue Sage
5. Hens and Chicks
6. Japanese Silver Grass
7. Santa Margarita Foothill Penstemon
8. Dwarf Deer Grass/ Pennisetum Little Bunny

*4 Rainbird Head popup adjustable Sprinklers

*1 Sprinkler Timer

Mulch will be covering the entire area



NID

Nevada Irrigation District Toilet Rebate Program

Nevada Irrigation District *treated water*, residential customers can receive up to a \$100 rebate by replacing an older inefficient toilet with a high efficient toilet.



Replacing inefficient toilets with **WATERSENSE MODELS**

can save
13,000 GALLONS
per year

How to get a rebate?

1. Check Availability
2. Complete step one of application
3. Purchase and install toilet
4. Complete step two of application
5. Receive approval notice
6. Receive your rebate check

*Funding is limited.
Rebates will be issued
on a first-come,
first-served basis until
funding is depleted.*



To check your eligibility: Call 530-273-6185 ext. 244 or email strongk@nidwater.com

Limit to one rebate per parcel. Single-family treated water residential customers only.

Visit <https://nidwater.com/conservation/incentives-rebates> for more information

Nevada Irrigation District launches a new program to provide toilet rebates

March 4, 2020

Nevada Irrigation District (NID) has launched a new toilet rebate program for its treated water residential customers. The program will offer up to \$100 when eligible customers replace their older inefficient toilets with high-efficient WaterSense-labeled toilets.

Toilets are a primary source of indoor water use, accounting for nearly 30 percent of an average home's indoor water consumption. Older, inefficient toilets can use as much as six gallons per flush.

According to WaterSense, by replacing an older non-efficient toilet with a WaterSense-labeled toilet, rated at 1.28 gallons per flush or less, you can save water by 20 to 60 percent. That's nearly 13,000 gallons of water savings every year.

NID's new program is aimed at helping treated water residential customer reduce water consumption and save money. Don't miss out on this opportunity! Rebate funding is limited, and will be issued on a first-come, first-served basis until depleted.

Customers: to check your eligibility, contact NID's Water Efficiency Technician at 530-273-6185 ext. 244 or email strongk@nidwater.com.

Visit <https://nidwater.com/conservation/incentives-rebates> for more information.



DROUGHT BRIEFING

Thursday, May 21, 2015
5:30 p.m.

Grass Valley Veterans Memorial Building
255 South Auburn Street
Grass Valley

NID officials will present the latest information:

- water storage
- precipitation
- drought contingency planning
- state's water right curtailments
- conservation targets
- long-range water storage options for the future

A short question and answer session is planned, time permitting.

How can we meet this year's challenges, remain prepared for next year and be better prepared for future droughts? We want to share information and hear from our community.

Community Drought Briefing May 21, 2015

- ▶ Brief History of NID
- ▶ NID Today
- ▶ Current Water Supply Conditions
- ▶ State Water Board Regulations
- ▶ District Conservation Efforts

Origins of NID

- ▶ Many canal systems and water rights were developed in the 1850's for hydraulic mining
- ▶ Heavy sedimentation occurred in the natural streams & rivers
- ▶ Sawyer decision 1884 led to the stop of hydraulic mining
- ▶ Left many canals abandoned or unused



Establishment of NID

- ▶ 1917 - 1921, Community Leaders with help from Farm Bureau began purchasing canal systems and water rights
- ▶ Those acquisitions included obtaining Bowman, French, Faucherie, Sawmill and Jackson lakes, and the rights for Scotts Flat Reservoir
- ▶ August 5th 1921 a public vote at the Brett Hart Hotel formally establishing NID
536 Yes to 163 No



Building Infrastructure



Addition of Placer County

- ▶ In 1927 farmers in Placer County voted to become members of the District
- ▶ The District purchased the Gold Hill Canal system from PG&E in 1933 to serve this area
- ▶ This expanded the District by 67,000 acres into Placer County
- ▶ Present day this area includes North Auburn to Lincoln up 65 toward Camp Far West Lake



1962 Storage Expansion

- ▶ 1962 NID leaders realized more storage was needed
- ▶ Voters agreed to a 65 million dollar bond for the formation of the Yuba-Bear Project
- ▶ Funding was gained through bonds and through an agreement between PG&E and NID to be paid back through 2013
- ▶ Added 157,000 acre feet storage with:



Jackson Meadows Reservoir



Scotts Flat Reservoir



Rollins Reservoir



NID Today

- ▶ NID encompasses 287,000 acres of land covering portions of Nevada, Placer, Yuba, and Sierra Counties
- ▶ NID has 280,000 Acre Feet Storage
- ▶ NID can produce over 82 MW of green hydroelectric power
- ▶ Power is generated along the path prior to consumption



The District Water Rights

- ▶ District exercises its 53 water rights
- ▶ 25 Pre - 1914 or riparian & 28 Post - 1914 water rights
- ▶ Rights allow for capture or diversion of 450,000 Acre Feet
- ▶ Consumptive uses include irrigation, domestic, and municipal

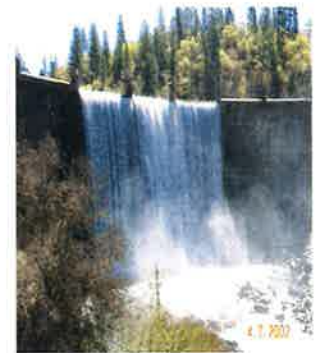

Domestic Water

- ▶ NID has 7 water treatment plants serving a population of nearly 50,000
- ▶ Treated over 3 billion gallons of water last year
- ▶ Operate and maintain over 40 water storage tanks with a total capacity of 41 million gallons
- ▶ The systems include over 300 miles of treated distribution pipelines
- ▶ Supply raw water to the City of Grass Valley & City of Nevada City for treatment



Irrigation Water

- ▶ NID waters irrigate over 31,000 acres
- ▶ Serves nearly 6,000 irrigation water customers
- ▶ Utilizing over 450 miles of canal
- ▶ NID provides the water to support a 98 million dollar ag industry in both Placer and Nevada Counties



Current Drought Conditions



Scotts Flat September 2014

NEVADA IRRIGATION DISTRICT BOWMAN LAKE PRECIPITATION TOTALS 2014-2015

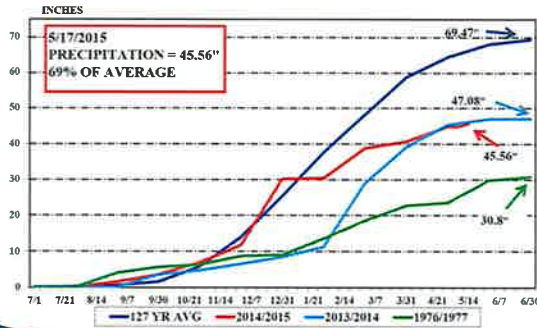

Snow Surveys

- ▶ District conducts its own watershed snow surveys
- ▶ Database dates as far back as the 1920's
- ▶ This year returned some of the lowest snowpack readings on record



Nevada Irrigation District May 1, 2015 Snow Survey

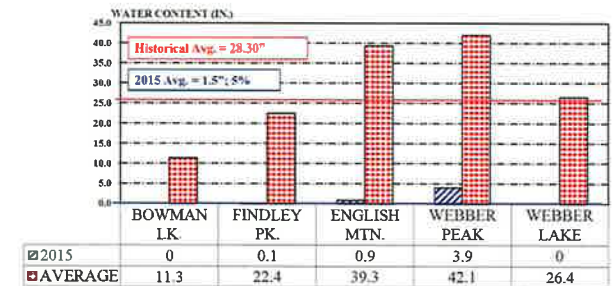

DISTRICT'S RESERVOIR STORAGE

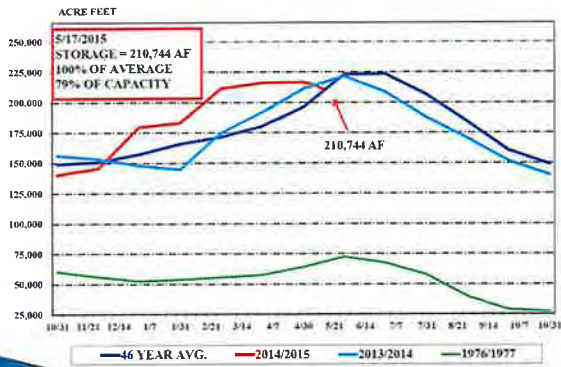

District's Drought Contingency Plan

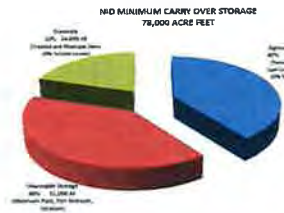

- Utilize snowpack, storage, and runoff forecasting to determine water availability
- Drought Contingency Plan provides guidance on minimum carryover amounts to preserve water and protect from a multiyear drought

- Provides guidance on when to buy supplemental water from PG&E

Storage Projection 2015

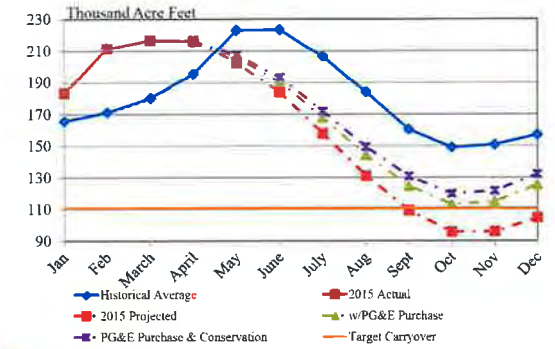

Statewide Conditions

- Reservoir storage statewide continues to lag
- Governor extended drought declaration to March 2016

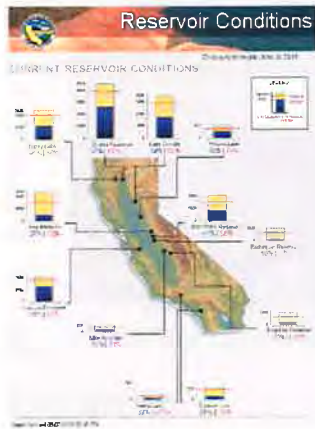

March 17, 2015 Drought Monitor

U.S. Drought Monitor California



May 12, 2015 Drought Monitor

U.S. Drought Monitor California



Recent State Board Actions

- March 1, Pre - 1914 Order for Additional Information
 - Required to provide documentation for the basis of pre - 1914 rights, 2014 diversion data and a projection of 2015 quantities
 - On-going monthly reporting requirement of diversion data
- May 1, Post - 1914 Water Right Curtailment Order
 - District had to cease directly diverting and collecting water to storage
 - In effect for 270 days or until lifted; may effect ability to collect water to storage in fall/early winter

Sacramento River / Delta Water Supply Vs Demand

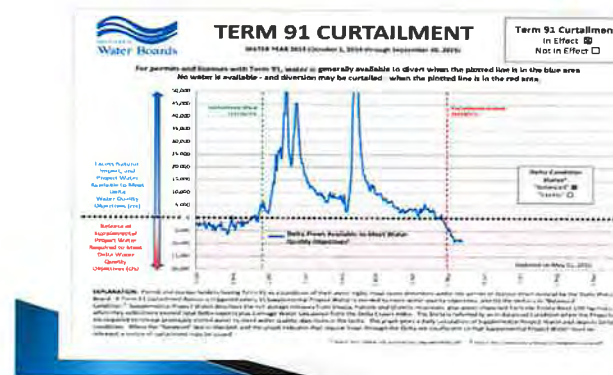

State Board May 5 Conservation Regulation - Water Purveyors

- Established conservation standard based on 2014 R-GPCD (Residential Gallons Per Capita Per Day)
- Goal 25% conservation statewide
 - 55 gallons per person per day is baseline
 - Different parts of the State have different requirements
 - Tiers range from 8% to 36% based on 2014
 - July - September usage
 - District is in the highest tier at 267 R-GPCD which mandates a 36% reduction
- Reporting of production, usage and water waste activities
- Provide customer with notification of possible leak
- Possible fines \$10,000 per day for non compliance

Treated End User Requirements

- Targeting a 36% reduction in usage from 2013
- Outdoor watering limited to 2 days a week maximum
- No outdoor watering during heat of day (10:00am to 6:00pm)
- No watering during or up to 48 hours after rain
- No watering that creates runoff
- No use of hoses unless fitted with an automatic shut-off nozzle
- No use of potable water in fountains unless water is recycled
- No washing down sidewalks or driveways
- No watering ornamental lawns along roadside
- No outdoor water on new construction unless drip or micro-spray
- No serving drinking water in restaurants unless requested
- Hotels/Motels provide an option of not washing towels and linens daily
- Possible fines of \$500 a day for violations

District Drought Contingency Plan Actions - Irrigation Water

- Target a 25% reduction
- Asking for voluntary reduction of service allotment
 - Customers will receive their previous allotment in 2016
 - Reductions of over 320 MI have been realized (2880 Acre Feet, 940 MG)
- New or increased irrigation water sales limited to the smallest amount for beneficial use
- Encourage efficient irrigation practices
- Additional conservation may be implemented at the discretion of the General Manager (based on storage)

Overview of District Actions

- Targeting 110,000 AF for carryover storage (75% avg.)
- Purchasing PG&E water to bolster carryover storage
- Increased priority on leak repair
- Continue to respond to water waste reports
- Continue to be conservative with releases from storage
- Closely monitor canal ends for excess
- Secure irrigation boxes with seals (zip ties)
- Addition of a Water Waste Policy
- Limit District flushing program (only flush as needed for public health and safety needs)
- Limit fire department drills
- Discourage planting of new lawns
- Establishing purchased water and conservation pricing through the Proposition 218 process

District Conservation

- Removing portions of lawn at headquarters and installing a drought demonstration landscape
- Update District drought web page
 - Graph reservoir storage levels month to month
 - Update conservation numbers monthly
- Offering irrigation efficiency workshops
- Continue support of Great Water Mystery in schools
 - In collaboration with SYRCL

How Do I Know if I Have Conserved?

Important 2015 Drought Update

Nevada Irrigation District is targeting a 30% reduction in water usage in comparison to the same year in 2013 and we are asking all customers to conserve. The Nevada Irrigation District Board of Directors has implemented portions of the Drought Contingency Plan. Mandatory outdoor water restrictions are given as follows and dates include:

- Limit watering to 2 days per week;
- No outdoor watering in the heat of the day, (10:00 a.m. to 6 p.m.);
- No watering during and 48 hours after a rain;
- No outdoor watering that causes excess runoff;
- No washing down driveways and sidewalks, unless for health and safety;
- No washing a motor vehicle with a hose, unless the hose is fitted with a shut-off nozzle;
- No use of potable water in a fountain or decorative feature, unless the water is recirculated.

Below is the 2011-2014 & 2017 consumption history as well as your individual meter for 2015. All figures are in gallons.

Year	Jan	Feb	Mar	Apr	May	Jun	Jul	Aug	Sep	Oct	Nov	Dec	Total
2011	11,700	8,470	10,200	12,000	13,000	14,000	15,000	16,000	17,000	18,000	19,000	20,000	150,000
2012	9,500	7,000	8,500	10,000	11,000	12,000	13,000	14,000	15,000	16,000	17,000	18,000	120,000
2013	10,000	7,500	9,000	11,000	12,000	13,000	14,000	15,000	16,000	17,000	18,000	19,000	130,000
2014	11,000	8,000	9,500	11,500	12,500	13,500	14,500	15,500	16,500	17,500	18,500	19,500	140,000
2017	12,000	9,000	10,500	12,500	13,500	14,500	15,500	16,500	17,500	18,500	19,500	20,500	150,000

For more water conservation tips visit <http://nidwater.com> or <http://www.nidwater.com>.
To report water waste please call 530-271-6799 or online at <http://nidwater.com/report-water-waste>.

How to Read a Meter



- Meters read in Hundred Cubic Feet (HCF)
- Use first 4 numbers from left to right for billing
- To convert to gallons multiply by 748
 - $4 * 748 = 2992$

CONSUMPTION COMPARISON	METER SIZE	METER READINGS PREVIOUS	METER READINGS PRESENT	DIFF. CONSUMED	TOTAL GALLONS CONSUMED	AVERAGE GALLONS USED PER DAY
USAGE DAY CURRENT 2992 HCF	5/8 IN MTR	0	4	4	2992	53

Indoor Conservation Tips

- FIX LEAKY TOILETS**
saves **30-50 GALLONS** per day/toilet
- WASH ONLY FULL LOADS OF CLOTHES**
saves **15-45 GALLONS** per load
- TAKE FIVE MINUTE SHOWERS INSTEAD OF 10 MINUTE SHOWERS**
saves **12.5 GALLONS** with a water efficient showerhead
- TURN OFF WATER WHEN BRUSHING TEETH OR SHAVING**
saves **10 GALLONS** per person/day
- INSTALL A HIGH-EFFICIENCY WATERSENSE-LABELED TOILET (1.28 GALLON PER FLUSH)**
saves **19 GALLONS** per person/day
- INSTALL AERATORS ON BATHROOM FAUCETS**
saves **1.2 GALLONS** per person/day

Outdoor Conservation Tips

- GET EFFICIENT**
 - invest in a smart controller
 - water less frequently, but longer and close to plant roots
 - redirect downspouts to capture rainwater and direct it to garden areas
- PLANT DROUGHT-RESISTANT TREES AND PLANTS**
saves **30-60 GALLONS** per 1,000 sq-ft, each time
- WATER PLANTS EARLY IN THE AM**
saves **25 GALLONS** each time you water
- INSTALL DRIP IRRIGATION**
saves **15 GALLONS** each time you water
- USE MULCH**
 - RETAIN MOISTURE: Less watering needed and grow healthier plants.
 - MODERATES TEMPERATURE: Cool soil in the summer and warm soil in the winter.
 - DECOMPOSES NUTRIENTS: Enrich soil and better soil quality.
 - DISCOURAGE WEEDS: Keep weeds away and reduce maintenance.
- ADJUST SPRINKLER TO WATER PLANTS, NOT DRIVEWAY**
saves **12-15 GALLONS** each time you water
- USE A BROOM TO CLEAN OUTDOOR AREAS**
saves **8-18 GALLONS** per broom

www.nidwater.com





Converting to Badger Meters

- Approximately 6,380 Badger meters installed as of June 18th, 2019



- Existing meters are replaced when components fail

BEACON HOME SCREEN

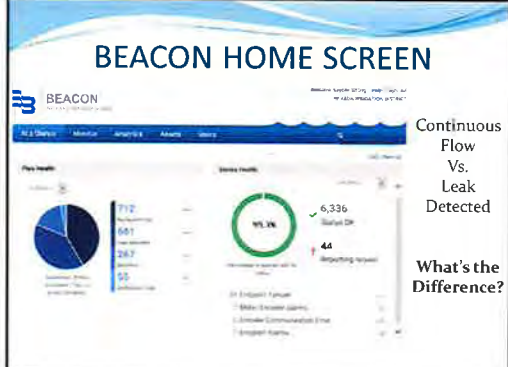

Continuous Flow Vs. Leak Detected

What's the Difference?

Project Background and Purpose

- NID began testing new meter technology in 2015
- Automatic Meter Infrastructure (AMI) will allow for better diagnosis of water usage
- Real-time access to water usage to help better track and understand usage
- Detect and resolve leaks
- Monitor meters and identify losses



BADGER METER



Model 21 (New Series) Meter Calibrated to 0.200

3NS

BEACON HOME SCREEN

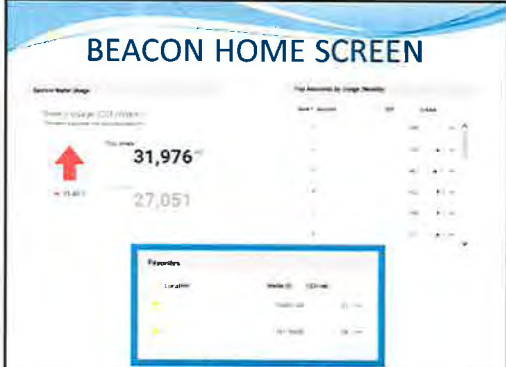

31,976

27,051

31NS

Summary of Fees and Charges

- Endpoints communicate via the cellular network. This data exchange requires that the District purchase service units.
- Each endpoint uses 1 service unit per month.
- The average cost per service units is \$0.86.
- Once the District has converted all meters, the annual cost for data exchange is estimated to be \$205,000.



The diagram illustrates the data exchange process. It shows two cylindrical meters at the top left. A blue arrow points from the meters to a cellular tower icon in the top right. Another blue arrow points from the tower to a computer monitor and a smartphone at the bottom left, representing the data being received and processed.

Thank You



The slide features three distinct logos for the Nevada Irrigation District (NID). From left to right: 1) A circular logo with 'NID' in the center, surrounded by a decorative border and the text 'NEVADA IRRIGATION DISTRICT' at the bottom. 2) A square logo with 'NEVADA IRRIGATION' at the top, 'NID' in the center, 'Organized 1911' below it, and 'DISTRICT' at the bottom. 3) A circular logo with a stylized blue wave or river shape inside, 'NID' at the bottom, and 'Organized 1911' in small text above it.



Treated Water Restrictions

- Washing down paved surfaces unless for health and safety
- Watering that causes excessive run off
- Washing of a vehicle with a hose unless fitted with a shutoff nozzle
- Cleaning of gutters by flooding with water
- Landscape watering during heat of day (10:00am to 6:00pm)
- Use of fountains and water features that do not recirculate water
- Outdoor watering during periods of rain

BADGER METER

The image shows a technical diagram of a Badger Meter with various components labeled. To the right is a photograph of a person in a dark uniform holding a white Badger Meter. Below the diagram is a digital display showing the number '345'.

Current Conservation Legislation

- Residential **Indoor** Standard- 55 GPCD
 - 52.5 GPCP by 2025
 - 50 GPCP after 2030
- 55 GPCD x Service Area Population x 365= **Indoor** Standard
 - NID 2018: approx. 67 GCPD
 - NID 2019: approx. 64 GCPD
- Industry experts project that people are already meeting this standard or don't have to go far
- Outdoor Standard
- www.home-water-works.org/calculator

Converting to Cellular Badger Meter

- Approximately 8,719 Badger meters installed as of October 1, 2020

- Existing meters are replaced when components fail

BEACON HOME SCREEN

The image is a screenshot of a dashboard titled 'BEACON'. It features a navigation bar with 'Home', 'Monitor', 'Analytics', 'Alerts', and 'Share'. The main area contains several widgets: a pie chart for 'Flow Health', a 'Device Health' section with a '6,336' value and a '44' value, and a 'Reporting Status' section. On the right side, there is text that reads 'Continuous Flow Vs. Leak Detected' and 'What's the Difference?'.

Notifying Customers of a Leak

Community Outreach

- Mulch Magic Program
 - 150 cubic yards of mulch
- Nevada County Ag in the Classroom: Farm Days
- Irrigation efficiency workshops
 - Irrigated Pasture Management

What Is The Secret To Conserving Water?

- TURN OFF WATER WHEN BRUSHING TEETH OR SHAVING
 - SAVES 10 GALLONS per person/day
- INSTALL EFFICIENT, WATERSENSE LABELED SHOWER HEADS
 - SAVES 1.2 GALLONS per minute
- WASH ONLY FULL LOADS OF CLOTHES
 - SAVES 13.45 GALLONS per load
- INSTALL AERATORS ON BATHROOM FAUCETS
 - SAVES 1.2 GALLONS per person/day
- FIX LEAKY TOILETS
 - SAVES 20-30 GALLONS per day/flush
- INSTALL A HIGH-EFFICIENCY, WATERSENSE LABELED TOILET (1.28 GALLON PER FLUSH)
 - SAVES 19 GALLONS per person/day
- TAKE FIVE MINUTE SHOWERS INSTEAD OF 10 MINUTE SHOWERS
 - SAVES 12.5 GALLONS with a water efficient showerhead

District Conservation

- Water Wise Landscape
 - Eliminated approximately 3,400 sq. ft. of turf
 - Replaced with water wise plants and mulch
 - Uses smart irrigation controller
 - Irrigation & plant handouts
 - Tours coming soon

Toilet Rebate Program

- Began 2020 with 200 available rebate
- NID treated water, residential customers
- Replace older inefficient toilet with a high efficient toilet
- Limit to one rebate per parcel
- 40 rebates issued as of October 1, 2020

50-70% of Treated Water is Used in Landscaping

- PRIORITIZE YOUR LANDSCAPE
 - 1. Use drought-tolerant plants
 - 2. Use mulch
 - 3. Use smart irrigation controller
- PLANT DROUGHT-RESISTANT TREES AND PLANTS
 - SAVES 3000 GALLONS per 1,000 sq. ft. over time
- WATER PLANTS EARLY IN THE AM
 - SAVES 15 GALLONS each time you water
- USE MULCH
 - Reduces water evaporation
 - Keeps soil cool
 - Prevents weeds
- GET EFFICIENT
 - Use smart irrigation controller
 - Use water-wise plants
 - Use mulch
- LET NATURE TAKE ITS COURSE
 - Let native plants grow
 - Use native plants
 - Use native plants
- EXHIBIT REGIONAL WATER OUTLOOKS
 - Use water-wise plants
 - Use water-wise plants
 - Use water-wise plants





LAKE WILDWOOD GARDEN CLUB

NID Today



- NID encompasses 287,000 acres of land covering portions of Nevada, Placer, Yuba, and Sierra Counties
- NID has nearly 280,000 Acre Feet of reservoir storage

- Serves over 25,000 customers
- Provides hydroelectric power and recreation opportunities



The District Water Rights

- District exercises its 53 water rights
 - ✓ 25 Pre - 1914 or riparian
 - ✓ 28 Post - 1914 water rights
- Rights allow for capture or diversion of approx. 450,000 Acre Feet
- Beneficial uses include irrigation, domestic, municipal, hydroelectric and recreation
- Currently under curtailment order from the SWRCB for Post - 1914 rights



NID Storage Reservoirs

Upper Mountain Division:

➤ Jackson Meadows (MY)	6,036' elevation	69,205 AF
➤ Jackson Lake (JC)	6,596' elevation	1,330 AF
➤ French Lake (CC)	6,835' elevation	13,840 AF
➤ Faucherie Lake (CC)	6,123' elevation	3,980 AF
➤ Sawmill Lake (CC)	5,863' elevation	3,030 AF
➤ Bowman Lake (CC)	5,564' elevation	68,510 AF

Lower Division:

Yuba System:

➤ Scotts Flat Reservoir (DC)	3,075' elevation	48,547 AF
------------------------------	------------------	-----------

Bear River System:

➤ Rollins Reservoir (BR)	2,171' elevation	65,988 AF
➤ Combie Lake (BR)	1,600' elevation	5,555 AF

Note: 1 Acre Foot (AF) = 1 Acre Covered 1 Foot Deep = 325,851 gallons

Domestic Water

- NID has 7 water treatment plants serving a population of nearly 50,000
- Treated over 3 billion gallons of water last year
- Operate and maintain over 40 water storage tanks with a total capacity of 41 million gallons
- The systems include over 300 miles of treated distribution pipelines

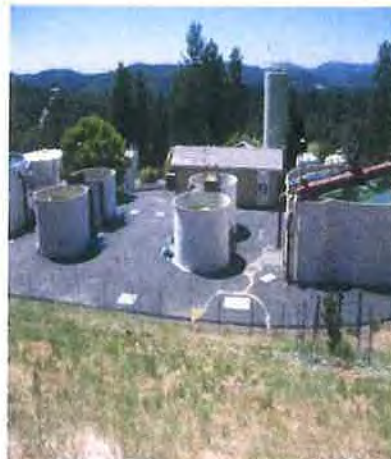

Irrigation Water

- NID water irrigates over 31,000 acres
- Serves nearly 6,000 irrigation customers
- Utilizing over 450 miles of canal
- NID provides the water to support a 98 million dollar ag industry in Placer, Nevada and Yuba counties



Hydroelectric and Recreation

- NID operates and maintains 7 powerhouses which can produce over 82 MW of green hydroelectric power
- NID's reservoirs offer camping, boating, swimming and fishing opportunities
- Over 100,000 visitors per year frequent NID recreation facilities



Current Drought Conditions



Scotts Flat Lake, September 2015

Treated Water Use Restrictions

- Targeting a 36% reduction in usage from 2013
- Outdoor watering limited to 2 days a week maximum
- No outdoor watering during heat of day (10:00am to 6:00pm)
- No watering during or up to 48 hours after rain
- No watering that creates runoff
- No use of hoses unless fitted with an automatic shut-off nozzle
- No use of potable water in fountains unless water is recycled
- No washing down sidewalks or driveways
- No watering ornamental lawns along roadside
- No outdoor water on new construction unless drip or micro-spray
- No serving drinking water in restaurants unless requested
- Hotels/Motels provide an option of not washing towels and linens daily
- Possible fines of \$500 a day for violations

2013-2015 Conservation Comparison

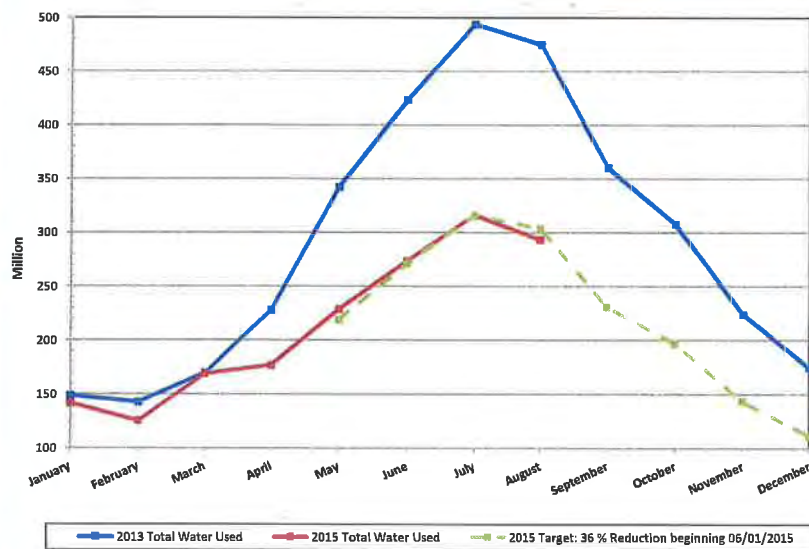

District Conservation

- Update District drought web page
 - ✓ Links to toilet and lawn replacement rebates
 - ✓ Graph reservoir storage levels month to month
 - ✓ Update conservation numbers monthly



- Removing portions of lawn at headquarters and installing a water wise demonstration landscape

District Conservation









- Offering irrigation efficiency workshops
- Continue support of The Great Water Mystery in schools
 - ✓ In collaboration with SYRCL



Detective Drizzle
Where does all the water go?

Permanently Reduce Your Use

OUTDOORS - Most of our water use goes towards watering our landscape. Reducing outdoors is the easiest way to save.

 <p>WATER EARLY OR LATE Water early in the morning or later in the evening when temperatures are cooler.</p>	 <p>BE WATER EFFICIENT Choose an irrigation system that's made of drip or micro-sprinklers. Avoid overhead.</p>
 <p>SKIP THE CAR WASH Wash your vehicle with a bucket, sponge, and hose instead. Change water.</p>	 <p>DON'T OVERWATER Water deeply but less frequently to create healthier and stronger landscapes.</p>
 <p>RETHINK YOUR LAWN Replace your grass with native landscaping.</p>	 <p>DON'T SPRAY Use a broom to clean driveways, sidewalks and patios.</p>
 <p>MULCH IT Place layers of mulch around trees and plants to reduce evaporation and keep the soil cool.</p>	 <p>WATCH SPRINKLERS Check your sprinkler system frequently and adjust sprinklers so only your lawn is watered.</p>

For more information and tips visit SaveOurWater.com

Water Wise Demonstration Garden



The image shows an aerial view of a demonstration garden. It features several distinct zones: a large area with circular mulch beds around trees, a central area with colorful native plants and flowers, and a section with a drip irrigation system. A winding path is visible through the garden. A small informational sign is located in the bottom right corner of the garden area.

How Do I Know If I Have Conserved?

Important 2015 Drought Update

Nevada Irrigation District is targeting a 36% reduction in water usage as compared to the same time in 2013 and we are asking all customers to conserve. The Nevada Irrigation District Board of Directors has implemented portions of the Drought Contingency Plan. Mandatory outdoor water use restrictions are now in place and they include:

- Limit watering to 2 days per week;
- No outdoor watering in the heat of the day, (10:00 a.m. to 6 p.m.);
- No watering during and 48 hours after rain;
- No outdoor watering that causes excess runoff;
- No washing down driveways and sidewalks, unless for health and safety;
- No washing a motor vehicle with a hose, unless the hose is fitted with a shutoff nozzle;
- No use of potable water in a fountain or decorative feature, unless the water is recirculated

Below is your 2013, 2014 & 2015 consumption history as well as your reduction target for: 12534 Any Drive, Grass Valley

All figures are in gallons

	2013	2014	2013 vs. 2014 % Difference	2015	2015 Reduction Target
Jan	11,048	8,971	25%	7,488	7,488
March	8,732	8,732	0%	6,984	6,984
May	2,430	8,732	25%	-	6,558
July	11,119	8,338	25%	-	8,338
September	8,732	7,490	31%	-	6,088
November	8,732	8,864	21%	-	6,984
TOTAL	59,802	48,927	19%	12,468	22,311

For more water conservation tips visit <http://nidwater.com> or <http://saveourwater.com/>
 To report water waste please call 530-271-6799 or online at <http://nidwater.com/report-water-waste/>

The state board has ruled that violators of the above regulations may be subject to fines of up to \$500

How to Read a Meter



- Know where to find your meter. Contact Customer Service if you need assistance.
- Meters read in Hundred Cubic Feet (HCF)
- Use first 4 numbers from left to right for billing
- To convert to gallons multiply by 748
 - ✓ $4 * 748 = 2992$

CONSUMPTION COMPARISON	METER SIZE	METER READINGS		HCF CONSUMED	TOTAL GALLONS CONSUMED	AVERAGE GALLONS USED PER DAY
		PREVIOUS	PRESENT			
USAGE/DAYS CURRENT 2992 /56	5/8 IN MTR	0	4	4	2992	53

Drought Outlook

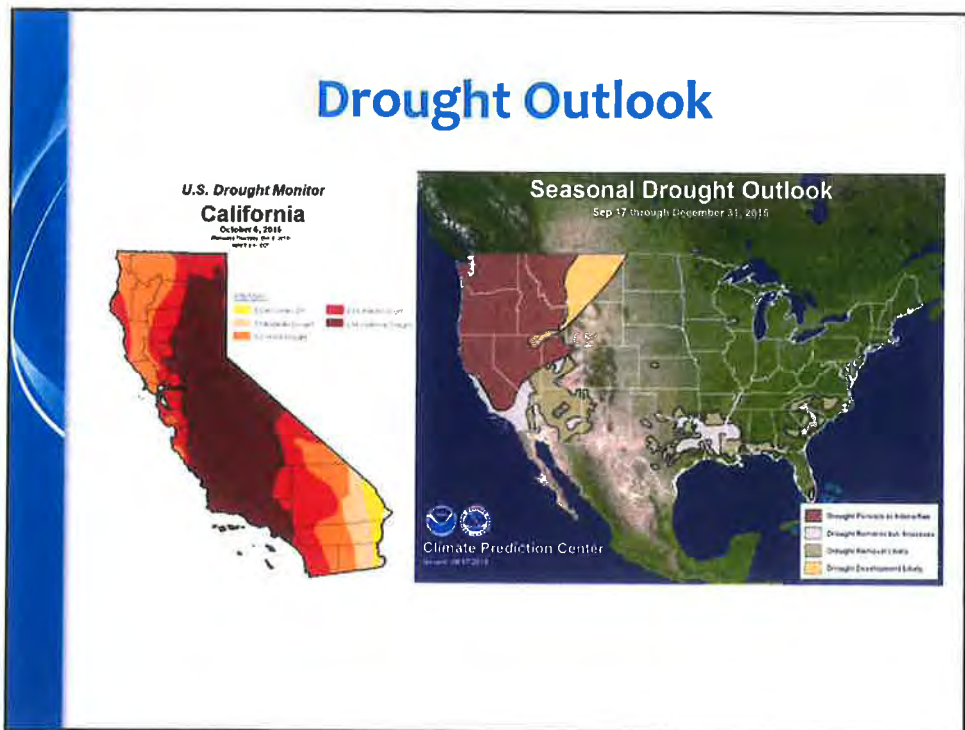

Winter Forecasts

STRONG EL NIÑO: CAUTIOUS OPTIMISM

There have been 6 recorded El Niños since 1950 (a small sample). Of those 6 events, 4 have been wet across NorCal. Reason to be cautiously optimistic! (9/20/2015)

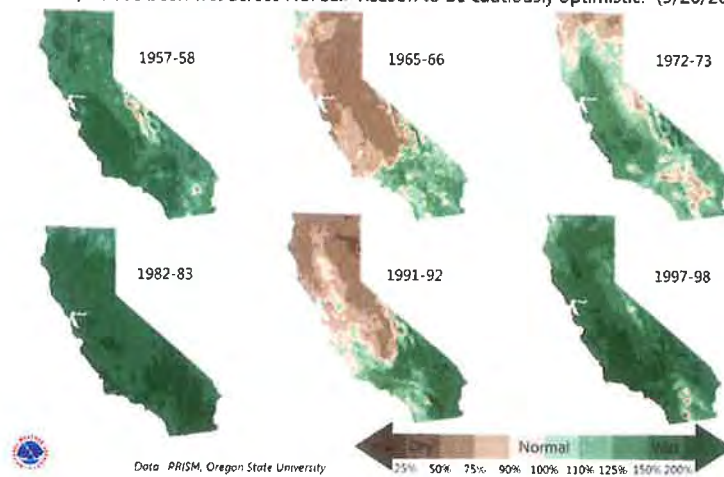

NID Reservoir Storage

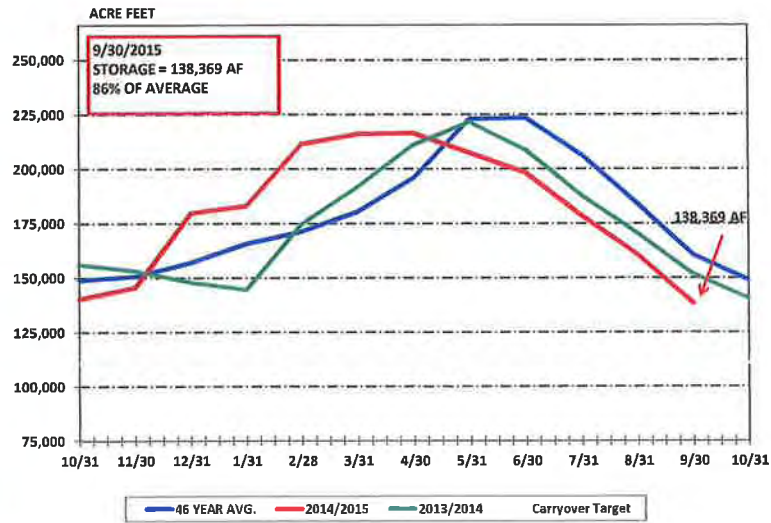

QUESTIONS?

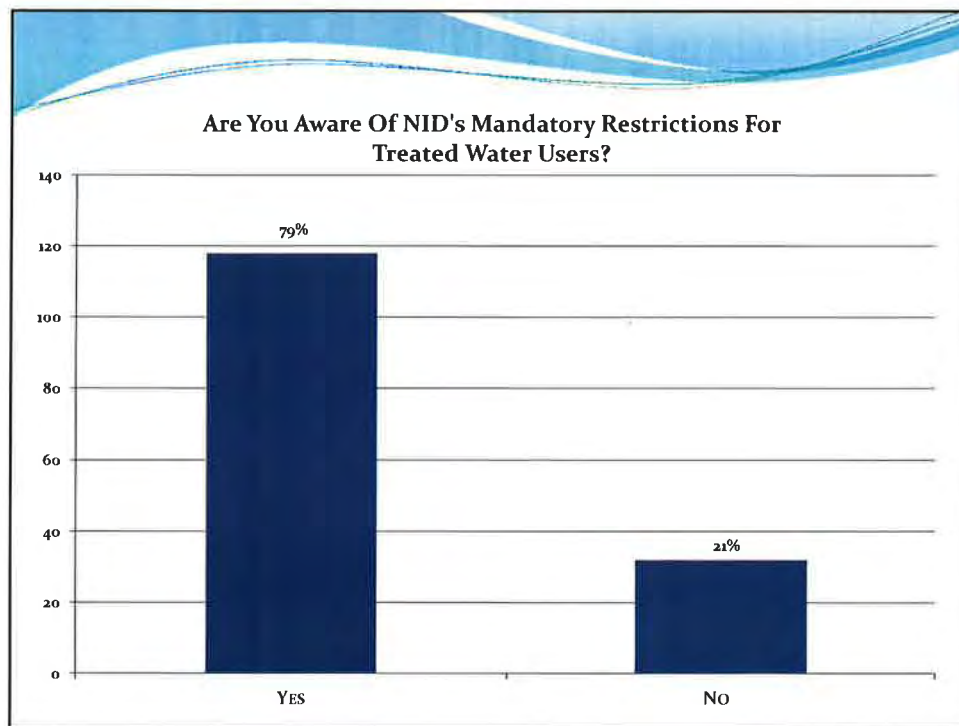

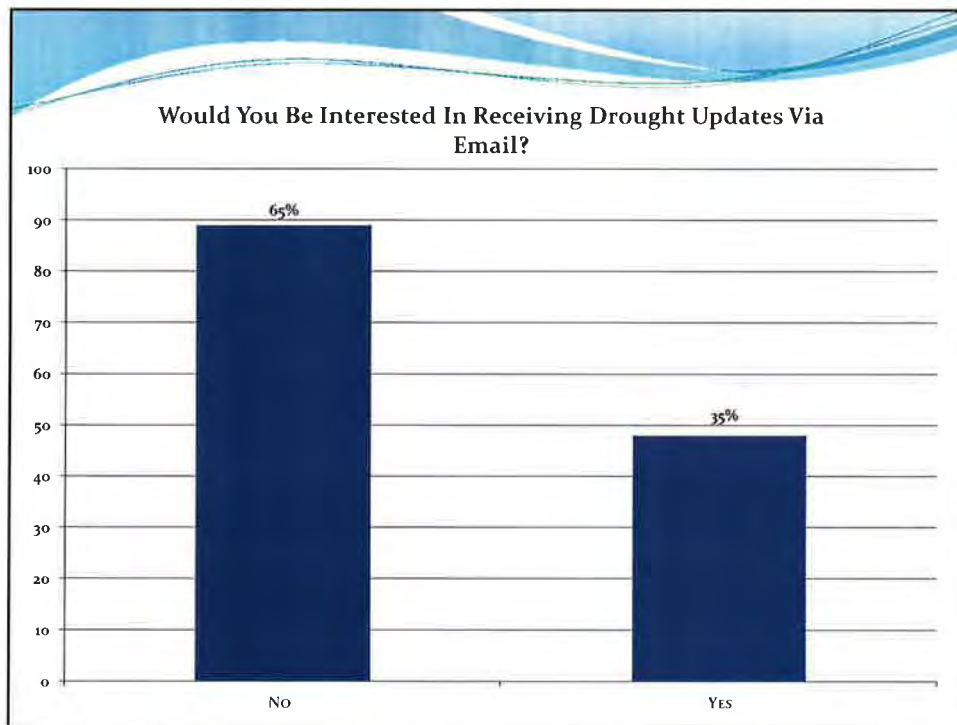
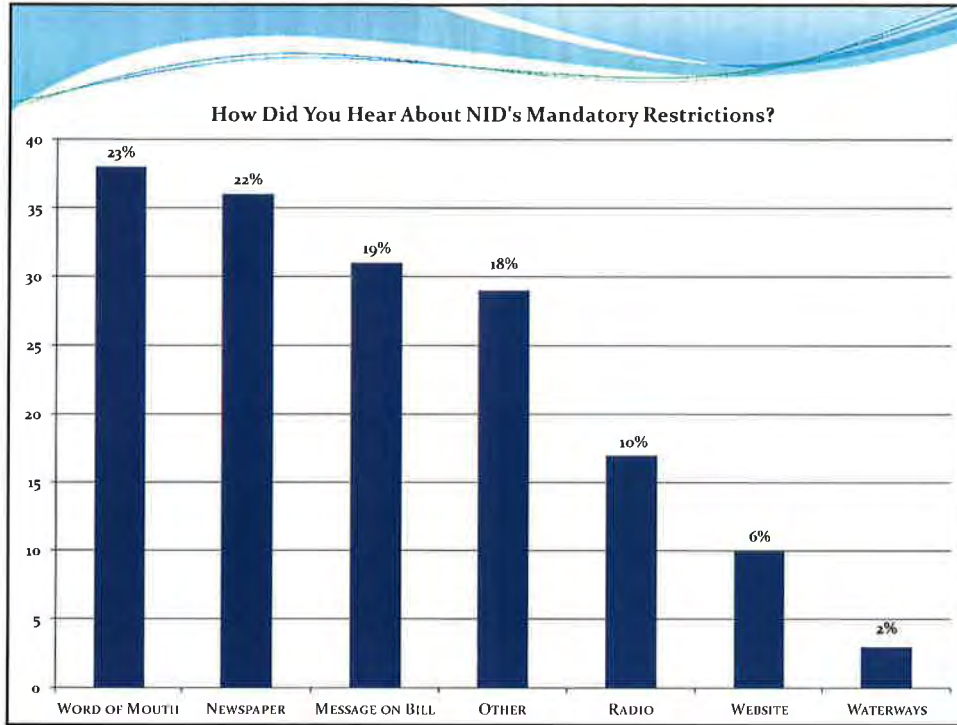

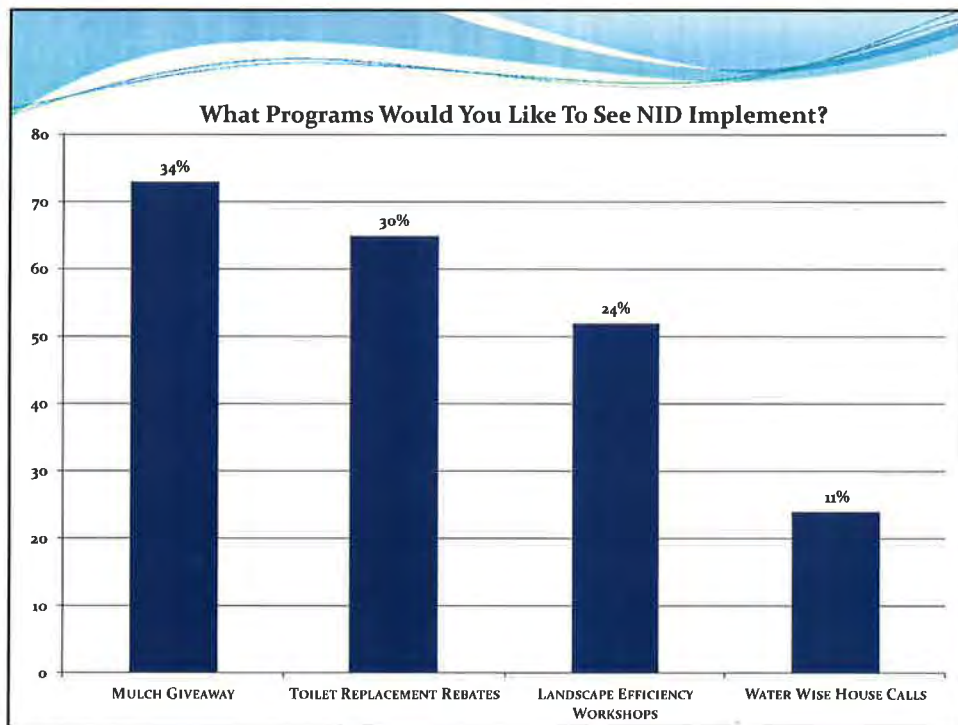
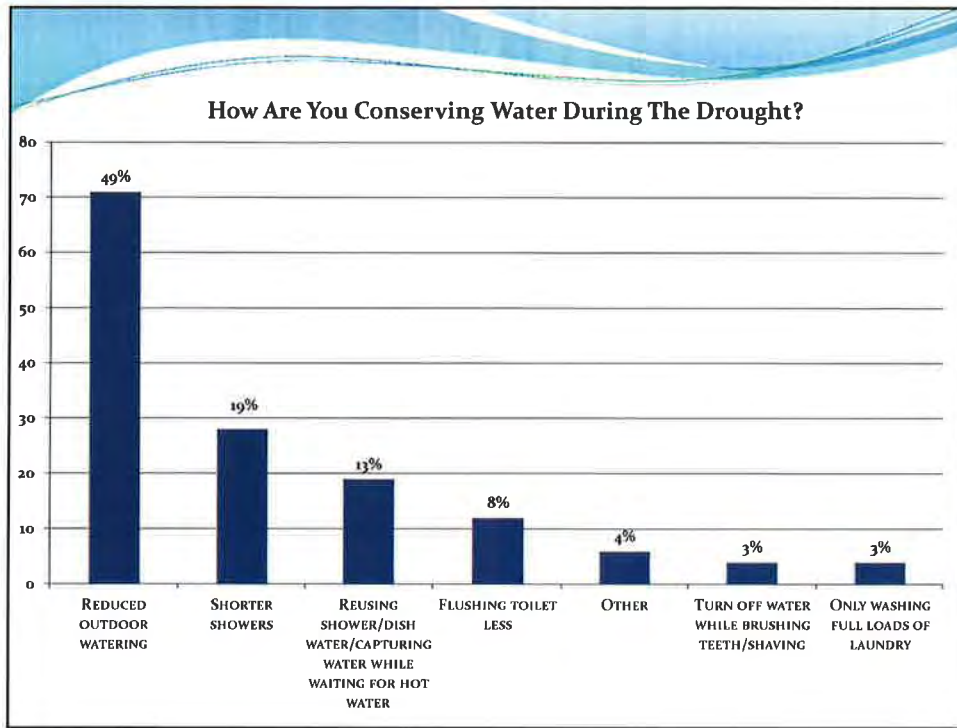

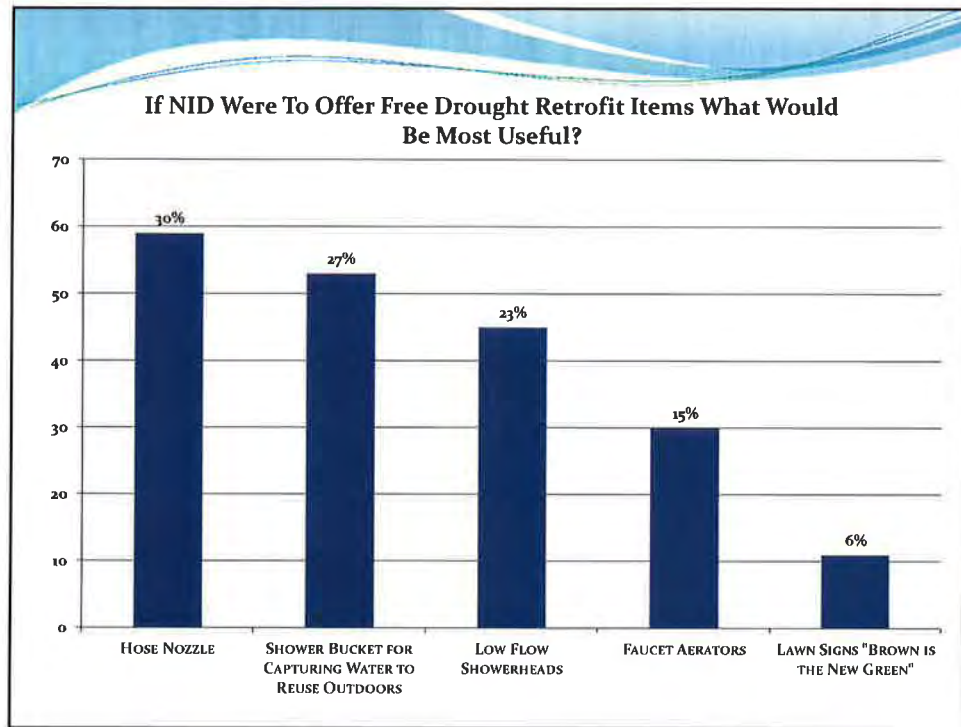





Appendix E: References

References

- CABY. Integrated Regional Water Management Plan 2020 Update [PUBLIC REVIEW DRAFT]. 2020.
- HDR. Water Supply Analysis TM – Final Report. November 12, 2020.
- Nevada County. Nevada County General Plan, Land Use Element. 2020.
- Placer County. Placer County General Plan (Part 1, Land Use and Circulation). Approved May 21, 2013.
- Starr Consulting and Palencia Consulting Engineers. Yuba/Bear River Watershed Sanitary Survey, 2017 Update. January 2017.
- United States Geological Survey (USGS). Ground-Water Conditions and Well Yields in Fractured Rocks, Southwestern Nevada County. 1984.
- Yuba County. Yuba County 2030 General Plan. Adopted June 7, 2011.



2020 URBAN WATER MANAGEMENT PLAN

BOARD WORKSHOP DRAFT

JUNE 23, 2021

AGENDA

- Introductions
- UWMP overview
 - Focus on demand and supply projections
 - Other elements can also be discussed
- UWMP process

UWMP APPROACH

- UWMP planning horizon covers 20 years
- NID facing longer term issues:
 - Climate change impacts to supplies
 - Regulatory impacts to supplies and demands
 - Changing demographics and water needs
 - Community identity
- Plan for Water is the vehicle and process for long-term planning that allows a more comprehensive analysis and alternatives development conducted at a pace that allows for consideration and discussion of multiple scenarios and responses specific to NID's unique services.
- Plan for Water was started in 2018, but put on hold. Anticipated to resume summer/fall 2021.
- This 2020 UWMP developed to meet regulatory requirements. Builds on past planning efforts as possible, but is focused on near-term 20-year planning horizon and required elements. Requirements focus on treated water system.

UWMP REQUIRED ELEMENTS

- System description
- Water demands
- SBX7-7 20x2020 gpcd compliance
- Water supplies
- Supply reliability and drought risk assessment
- Water shortage contingency plan
- Demand management program

WATER CUSTOMERS/USES

- Treated water retail
 - Domestic water use customer served by NID
- Treated water wholesale
 - Other water entities purchase treated water from NID to serve respective entity customers
- Raw water retail
 - Irrigation season
 - Fall/winter
 - Annual
- Raw water wholesale
 - Other water entities purchase from NID to serve respective entity customers (treated/raw)
- Water rights/FERC environmental instream flow requirements

TREATED RETAIL CUSTOMER TREND

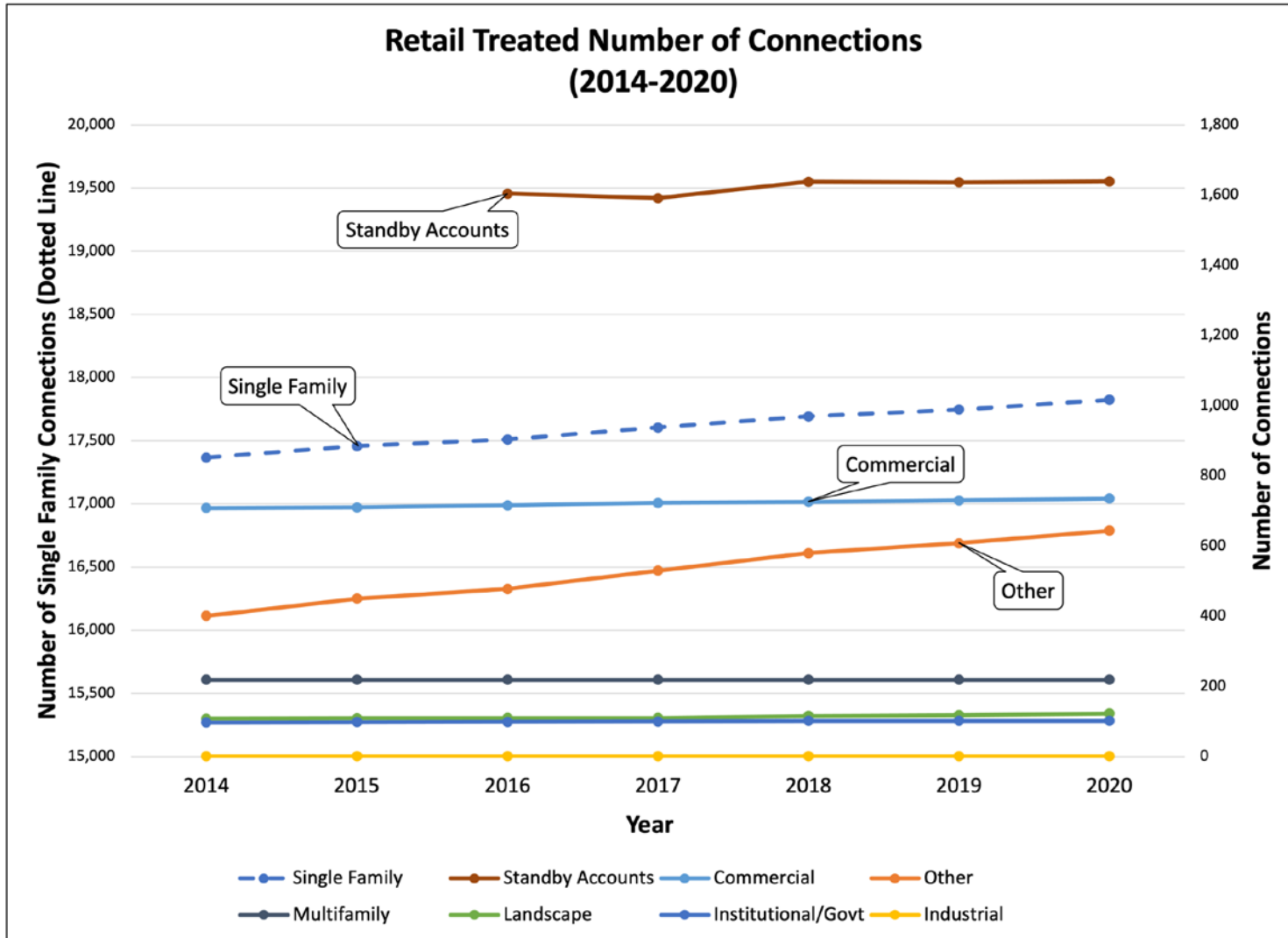

RAW WATER RETAIL CUSTOMER TREND

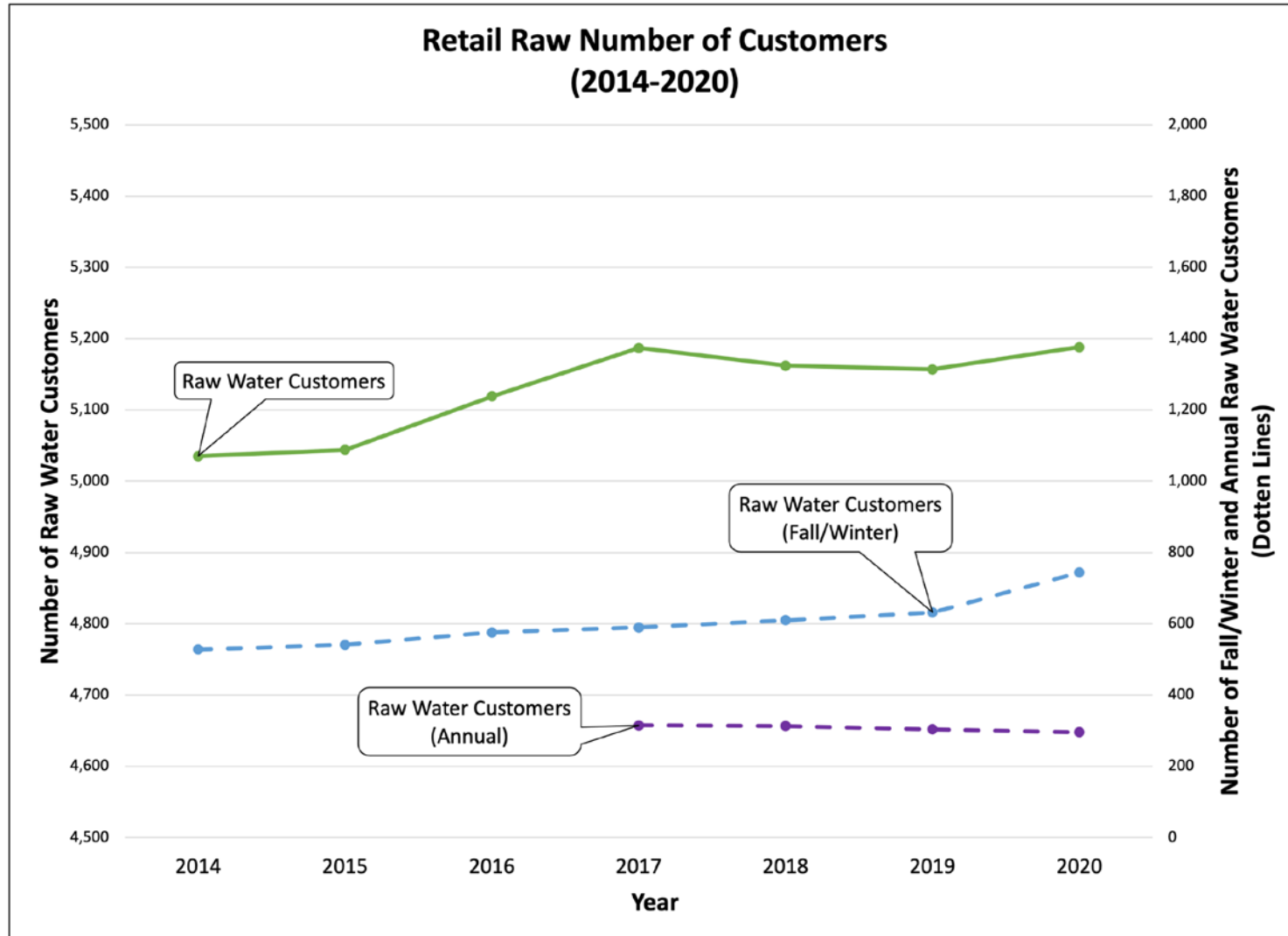

CONNECTION PROJECTIONS

- Recent data indicates customer base continues to grow.
- NID customer growth de-linked from population projections due to latent demand (existing residences that eventually become NID customers)
 - 2016-2020 – 60 Percent latent demand new customers, 40 percent extension new customers
 - 2020 Standby accounts = 1,639 (indication of potential for latent demand)
- Retail connections – based on recent historic growth rates per category
 - Treated retail projections just clear current Standby que by 2035, but it is assumed projections include both latent and new construction customers
 - Raw water retail projections assume soft service boundary (parcels near existing canals) from RWMP
- CA Department of Finance projects population growth in Nevada/Placer counties
 - Combined county annual growth to 2040 = 0.79% - includes areas outside NID service area
- Land use demand capacity versus probable demand capacity
 - General Plan land use designations and development plans versus system infrastructure locations and topography should be further investigated in Plan for Water

CUSTOMER CONNECTION PROJECTIONS

Customer Category	2020	2025	2030	2035	2040
Single Family	17,824	18,206	18,587	18,969	19,351
Multi Family	219	227	235	242	250
Commercial	735	758	780	803	825
Industrial	1	1	1	1	1
Institutional	102	106	110	115	119
Landscape	123	136	148	161	173
Other	644	847	1,049	1,252	1,454
Total Treated Retail:	19,648	20,281	20,910	21,543	22,173
Raw Water	5,188	5,316	5,444	5,571	5,698
Treated Wholesale	2	2	2	2	2
Raw Wholesale	4	4	4	4	4

WATER DEMAND AND USES

- **Treated water unit water demands**
 - Forthcoming Water Use Objective regulations will further define allowable treated water demands
 - Current unit water demands utilized, but should be revisited once WUO are completed by DWR and NID knows the total WUO allowance
 - Do not expect significant changes to NID's overall water demand projections. Existing residential demands close to range of expected budgets, and treated water demands are only 5-6% of total demand
- **Raw water customer difficult to quantify exact unit demands due to raw water system operations**
- **Developed a water duty factor to account for unknowns throughout raw water system**
 - Actual customer use
 - Carriage water
 - Fall/winter/annual demands
 - Losses and other unknown uses
 - 25 AFY/customer count – average of aggregate
 - For UWMP short-term projecting needs only
 - Needs further refinement of land use and topography capacity for long-term management options in Plan for Water

WATER DEMAND AND USES - CONTINUED

- Unrecoverable environmental instream flow requirements
 - Water rights and FERC license require a portion of NID's water rights remain in /diverted to streams
 - Currently 7,665 AFY. Proposed values in pending FERC license much higher
 - Most of these diversions are unrecoverable by NID for customer use

Year Type	Unrecoverable Flow, AFY
Wet	58,257
Above Normal	51,637
Below Normal	41,900
Dry	27,823
Critically Dry	22,674
Extremely Dry	16,359

WATER DEMAND AND USES - CONTINUED

- Wholesale customers
 - Nevada City – 500 AFY raw water
 - Grass Valley – 1,000 AFY raw water, 90 AFY treated
 - Lake Vera Mutual – 25 AFY treated
 - NC School of Arts – 36 AFY raw
 - City of Lincoln/PCWA – increasing from 1,517 AF (2020) up to 3,898 AFY per City of Lincoln projections

DEMAND PROJECTIONS – TREATED RETAIL

Customer Category	2020, AF	2025, AF	2030, AF	2035, AF	2040, AF
Single Family	6,429	6,567	6,705	6,842	6,980
Multi Family	636	640	661	683	705
Commercial	759	802	826	850	874
Industrial	0.22	0.22	0.22	0.22	0.22
Institutional	476	499	518	538	557
Landscape	222	230	251	272	294
Other	28	34	43	51	59
Total Treated Retail:	8,550	8,772	9,004	9,236	9,469

DEMAND PROJECTIONS - TOTAL

Category	2020, AF	2025, AF	2030, AF	2035, AF	2040, AF
Retail Treated	8,550	8,772	9,004	9,236	9,469
Wholesale Treated	108	115	115	115	115
Water Loss Treated	1,200	889	912	935	958
Total Treated:	9,858	9,775	10,031	10,287	10,542
Raw Water Retail Duty	139,519	132,885	136,073	139,260	142,447
Raw Water Wholesale	2,891	3,776	4,231	4,833	5,434
Unrecoverable Instream Flows	9,410 (7,665)	16,359- 59,527	16,359- 59,527	16,359- 59,527	16,359- 59,527
Total Water Demands:	161,678	162,795- 205,963	166,694- 209,862	170-739- 213,907	174,782- 217,950

SBX7 COMPLIANCE

- Reduce gallon per capita day (gpcd) 20% by 2020

Parameter	Value
2020 Gross Water Use	9,858 AF
2020 Population	52,733
2020 Actual gpcd	167 gpcd
2020 Target gpcd	197 gpcd
Compliance Achieved?	Yes

SUPPLY

- **Watershed runoff and storage**
 - Rights for runoff and storage total about 450,000 AFY
 - Actual available less due to temporal differences between rights, demand patterns, and storage strategies
- **PGE Contract**
 - Up to 54,361 AFY
 - Actual available much less due to temporal differences, available budget to purchase, and other NID supply strategy actions
- **Recycled**
 - Effluent from wwtp comingled in streams and diverted into canals during irrigation season

PROJECTED AVERAGE YEAR SUPPLY

Supply Source	2025 AF	2030 AF	2035 AF	2040 AF
Contract Purchase (PG&E)	7,500	7,500	7,500	7,500
Watershed Runoff	233,066	233,066	233,066	233,066
Carryover Storage	143,968	143,968	143,968	143,968
Recycled Water	1,408	1,408	1,408	1,408
Total Projected Supply:	385,942	385,942	385,942	385,942

- PGE supply estimate assumed, and could vary based on actual supply strategy at time
- Watershed runoff and storage values assumed from average runoff year 1989
- Recycled water assumes 2020 values are utilized

PROJECTED AVERAGE YEAR SUPPLY TO DEMAND

Category	2025 AF	2030 AF	2035 AF	2040 AF
Projected Supply	385,942	385,942	385,942	385,942
Projected Demands	188,336 – 205,963	192,235 – 209,862	196,280 – 213,906	200,323 – 217,950
Excess Supply:	197,906 – 179,979	193,707 – 176,080	189,662 – 172,036	185,619 – 167,992

- Demand assumes unrecoverable instream flows in range of year types Wet to Below Normal values (41,900 AF to 59,527 AF)

DROUGHT PROJECTION REQUIREMENTS

- Single Dry Year in 5-Year increments (1977)
- 5-year drought in 5-Year increments
- Drought Reliability Assessment – from 2021 to 2025 assuming 5-Year drought
- Demand increased 10% during drought to account for higher irrigation needs
 - “Unconstrained demand” per requirements = without required reductions
- 5-year drought assumes actual supply availability during 1987-1991 drought
- Recycled water supply not included in dry years as NID has no rights/contracts

PROJECTED SINGLE DRY YEAR

Category	2025 AF	2030 AF	2035 AF	2040 AF
Projected Supply	91,807	91,807	91,807	91,807
Projected Demands	177,436 - 202,977	181,723 - 207,264	186,173 - 211,714	190,621 - 216,162
Excess Supply:	(85,629) - (111,170)	(89,916) - (115,457)	(94,366) - (119,907)	(98,814) - (124,355)

- Demand assumes unrecoverable instream flows in range of year types Extremely Dry to Below Normal values (16,359 AF to 41,900 AF)
- Demands increased 10 percent during dry year

PROJECTED 5-YEAR DROUGHT AND DROUGHT RISK ASSESSMENT

Drought Year	2025 AF	2030 AF	2035 AF	2040 AF
Year 1 Supply to Demand Difference	1,708 - (23,834)	(2,580) - (28,121)	(7,030) - (32,571)	(11,478) - (37,019)
Year 2 Supply to Demand Difference	(806) - (26,347)	(5,093) - (30,634)	(9,543) - (35,084)	(13,991) - (39,532)
Year 3 Supply to Demand Difference	203,911 - 178,370	199,623 - 174,082	195,173 - 169,632	190,725 - 165,184
Year 4 Supply to Demand Difference	76,761 - 51,220	72,473 - 46,932	68,023 - 42,482	63,575 - 38,034
Year 5 Supply to Demand Difference	105,485 - 79,944	101,197 - 75,656	96,747 - 71,206	92,299 - 66,758

- Demand assumes unrecoverable instream flows in range of year types Extremely Dry to Below Normal values (16,359 AF to 41,900 AF)

DROUGHT ANALYSIS OBSERVATIONS

- Supply highly impacted by short, extreme events
- Longer drought events afford opportunity to adjust strategies, decrease demands, and increase carryover storage opportunities
- Plan for Water should investigate drought impact mitigation effectiveness through supply management optimization and demand management compared to infrastructure alternatives
- These are results from selected drought – Plan for Water should consider impacts from other types of droughts as well

WATER SHORTAGE CONTINGENCY PLAN

- Annual Assessment procedures
- Water Shortage Stages and Responses
- Communications
- Compliance and Enforcement
- Financial Considerations
- Monitoring, Reporting, and Refinement
- Seismic Risk

WATER SHORTAGE STAGES

Stage	Demand Reduction	Key Requirements (each stage includes efforts of previous stages)
Normal	--	Voluntary conservation program in place, restrictions against water waste
1	Up to 10%	Voluntary conservation measures, increased messaging, raw water customers allowed to reduce orders
2	Up to 20%	Treated water irrigation limited to every other day, mandated raw water delivery schedule changes, purchase available contract water for carryover storage goals
3	Up to 30%	Treated water irrigation limited to 2 days per week, mandated raw water delivery schedule changes, purchase available contract water for carryover storage goals
4	Up to 40%	Treated water irrigation limited to 1 day per week, mandated raw water delivery schedule changes, purchase available contract water for carryover storage goals
5	Up to 50%	Treated water irrigation prohibited, mandated raw water delivery schedule changes, purchase available contract water for carryover storage goals
6	Over 50%	Treated water health and safety water use only, mandated raw water delivery schedule changes, purchase available contract water for carryover storage goals

NEXT

Questions/Discussion